

APM-1

Transmitter/controller for pH, redox,
NH₃, temperature and standard signals



Operation Instructions

**WARNING:**



A sudden malfunction of the instrument, or one of the sensors connected to it, could potentially result in dangerous, overdosing! Suitable preventive measures must be in place to prevent this from happening.

**Note:**





Please read these Operating Instructions before placing the instrument in operation. Keep the manual in a place which is accessible to all users at all times.

**Resetting the brightness of the LC display:**

If the brightness setting has been adjusted so that the display text is no longer legible, the basic setting can be restored as follows:

- * Switch off the supply voltage.
- * Switch on the supply voltage and immediately press and hold the  and  keys simultaneously.

To set the operator language:

- * Press the  key for longer than 3 seconds.
 - * Select the appropriate language with the  and  keys.
 - * Briefly press the  key.
-

Content

1	Typographical conventions	8
1.1	Warning signs	8
1.2	Reference signs	8
2	Description	9
3	Instrument identification	11
3.1	Nameplate	11
3.2	Type designation	12
3.3	Accessories (included in delivery)	13
3.4	Accessories (optional)	13
4	Assembly	14
4.1	General	14
4.2	Dimensions	14
5	Installation	15
5.1	Installation instructions	15
5.2	Electrical isolation	16
5.3	Connection	17
6	Operation	21
6.1	Controls	21
6.2	Display	22
6.3	Principle of operation	23
6.4	Measuring mode	26
6.5	Input/output information	27
6.6	User level	32
6.7	Administrator level	33
6.8	MANUAL mode / Simulation mode	35
6.9	HOLD mode	37
7	Commissioning	40
7.1	Getting started	40
7.2	Setting examples	41
8	Calibrating a pH measurement chain	46
8.1	Notes	46
8.2	General information	46
8.3	Zero point (1-point) calibration	48
8.4	2-point calibration	49

Content

8.5	3-point calibration	51
8.6	pH Antimony measurement chain	54
8.7	ISFET pH combination electrodes	54
9	Calibrating a redox measurement chain	55
9.1	Notes	55
9.2	General information	55
9.3	Zero-point calibration (one-point offset calibration)	57
9.4	2-point calibration	58
10	Calibrating an ammonia measuring cell	60
10.1	Notes	60
10.2	General information	60
10.3	Zero point (1-point) calibration	61
11	Calibrating a sensor with a standard signal	63
11.1	General information	63
11.2	Linear operating mode	65
11.3	pH operating mode	69
11.4	Conductivity operating mode	70
11.5	Concentration operating mode	76
11.6	Chlorine measurement operating mode, pH-compensated	77
12	Calibration logbook	79
12.1	General information	79
13	Controller	81
13.1	General information	81
13.2	Controller functions	81
13.3	Software controllers and outputs	82
13.4	Configuration of higher order controllers	84
13.5	Parameter sets	84
13.6	Sample configurations	85
14	Setup program	88
14.1	Configurable parameters	88
14.2	Documenting the instrument configuration	89
14.3	Special features for "Datalogger"	90
15	Eliminating errors and faults	92

Content

16	Technical data	94
17	Retrofitting optional boards	97
17.1	Identifying an optional board	97
17.2	Removing a plug-in module	99
17.3	Inserting a plug-in module	99
17.4	Retrofitting optional boards (field housing)	100
18	Appendix	102
18.1	Glossary	102
18.2	Parameters of the User level	112
19	Disposal.....	123
20	EU Declaration of Conformance	124
21	UK Declaration of Conformance	125



The instruction manuals on our website www.kobold.com are always for currently manufactured version of our products. Due to technical changes, the instruction manuals available online may not always correspond to the product version you have purchased. If you need an instruction manual that corresponds to the purchased product version, you can request it from us free of charge by email (info.de@kobold.com) in PDF format, specifying the relevant invoice number and serial number. If you wish, the operating instructions can also be sent to you by post in paper form against an applicable postage fee.

Index

1-point calibration - ammonia 61
1-point calibration - pH 48
2-point calibration 102
2-point calibration - pH 49
3-point calibration - pH 51
3-point calibration . 103

A

Accessories 13
Administrator 33
Asymmetrical connection 109–111

B

Basic setting 33
Binary inputs and outputs
States 30

C

Calibration
Ammonia, 1-point 61
Ammonia, zero point 61
Antimony 54
ISFET 54
Logbook 79
pH ISFET 54
pH, 2-point 49
pH, antimony 54
Redox, one-point 57
Redox, zero-point 57
Standard signal 63
Standard signal, options 64
Calibration release 35
Configurable parameters 88
Controller
"Higher order" switching functions 81
"Simple" switching functions 81
General information 81
Parameter sets 84
Controller functions 81
Controllers
Configuration of "higher order" controllers
84
Setting example, limit monitoring 85
Setting example, pulse length output 86
Customer settings 112

D

Datalogger
Special features 90
Date of manufacture 11

Delete 35
Display 22

E

Electrical isolation 16

F

Factory settings 112

G

Getting started 40

H

HOLD mode 37

I

Info
Device 32
Hardware 31
Installation position 14
ISFET sensor 111

K

Key combinations 27

L

Limit functions 103

M

Manual 31
MANUAL mode 35
Analog outputs 37
Binary outputs 37
Controller 36
Deactivation 39
Switching outputs 36
Manual mode overview 31
Menu
Customized 28
Min/max values 28–29
Mounting location 14

O

Output 29

Optional inputs

 Current values 30

Output level display 29

P

Parameter overview 112

Password 33

Principle 23

Principle of operation 27

R

Rapid access 27

Reference signs 8

S

Setting example

 pH difference measurement 43

 pH measurement 41

Setup program 88

Simulation mode 35

Simulation of binary outputs 37

States 30

Sunlight 14

T

Temperature compensation 109

U

User 32

User data 28

W

Warning signs 8

Wash timer 111

Washing contact 111

Z

Zero point calibration 102

1 Typographical conventions

1.1 Warning signs



Danger

This symbol is used when there may be **danger to personnel** if the instructions are ignored or not followed correctly!



Caution

This symbol is used when there may be **damage to equipment or data** if the instructions are ignored or not followed correctly!

1.2 Reference signs



Note

This symbol is used to draw your **special attention** to a remark.

abc¹

Footnote

Footnotes are remarks that **refer to specific points** in the text. Footnotes consist of two parts:

A marker in the text and the footnote text.

The markers in the text are arranged as consecutive superscript numbers.

*

Instruction

This symbol indicates the description of an **action to be performed**.

The individual steps are marked by this asterisk.

Example:

* Briefly press the  key.

2 Description

Inputs/outputs In addition to the main input (pH/redox) and the secondary input (temperature compensation), the basic instrument alone has two binary inputs, two relays, one power supply for external sensors and a setup interface.

Input signals can be shown as numbers or as a bar graph on the graphic display. Parameters are displayed in plain text for easily comprehensible and reliable operation.

Optional Three further slots can be fitted with extensive additional configurable inputs and outputs and interfaces.

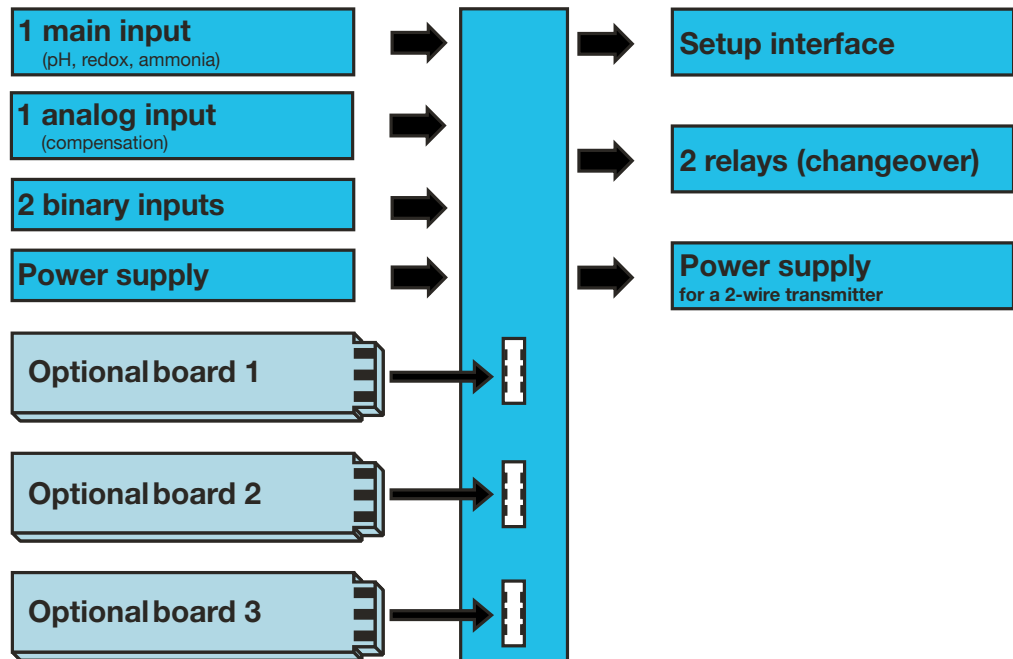

Application The instrument is suitable, for example, for displaying, measuring and controlling:

- pH value and/or redox potential.
- Free chlorine, chlorine dioxide, ozone, hydrogen peroxide and peracetic acid, in combination with suitable sensors.
- (Hydrostatic) liquid levels with 2-wire transmitters (level probes).
- Flow rate in conjunction with transmitters.
- Two temperature measuring points.
- Most sensors and transmitters that output standard signals (0 - 10 V or 0(4) - 20 mA).

Because temperature measurement is integrated, temperature compensation takes place quickly and precisely, which is particularly important for many analytical measurements.

Key features

- Display: mg/l, pH, mV, $\mu\text{S/cm}$, etc. Special settings are also possible with the setup program
- Configurable display text (operator level)
- Alarm text with color change

2 Description

- A choice of display visualizations: large numbers, bar graph or tendency (trend) display
- Four limit controllers
- Integrated calibration routines: with 1, 2 and 3 points
- Math and logic module (optional)
- Calibration logbook
- Three optional slots
- Selectable languages: English, German, French, etc.
- Setup program provides: convenient programming, system documentation
- RS422/485 interface (optional)
- PROFIBUS-DP interface (optional)

3 Instrument identification

3.1 Nameplate

on the transmitter

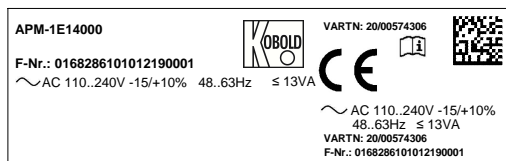

The date of manufacture is encoded in the "F No." (serial number):
1122 means year of manufacture 2011 / calendar week 22

3 Instrument identification

3.2 Type designation

Order Details (Example: APM-1 E 1 0 0 0 Y)

Model	Version	Housing	Power supply	Option 1 (Optional board)	Option 2 (Optional board)	Option 3 (Optional board)	Special
APM Evaluation electronics pH/redox	1 = Compact-Line (new) Input: 1x pH/redox, 1x temperature/ standard signal, 2x binary input sensor supply: 2-wire transmitter, 2 relays	E = for panel mounting F = Field housing S = Field housing with wall mounting bracket R = Field housing with pipe mounting bracket	1 = 110...240 V _{AC} -15%/+10%, 48...63 Hz 2 = 20...30 V _{AC/DC} , 48...63 Hz	4 = analogue output 0(4)-20 mA, 0(2)-10V (Standard) 0 = without 1 = universal input (resistance, current, voltage) 2 = 1 relay (changeover contact) 3 = 2 relays (NO with common pin) 5 = 2 Photo-Mos relay switch (0.2A) 6 = 1 semiconductor relay TRIAC (1A) 7 = 1 power supply 4.85V (e. g. for ISFET sensor) 8 = 1 power supply 12V _{DC} (e. g. for inductive proximity switch)	0 = without 1 = universal input (resistance, current, voltage) 2 = 1 relay (changeover contact) 4 = analogue output 0(4)-20 mA, 0(2)-10V 5 = 2 Photo-Mos relay switch (0.2 A) 6 = 1 semiconductor relay TRIAC (1A) 7 = 1 power supply 4.85V (e. g. for ISFET sensor) 8 = 1 power supply 12 V _{DC} (e. g. for inductive proximity switch)	0 = without 1 = universal input (resistance, current, voltage) 2 = 1 relay (changeover contact) 3 = 2 Relais (NO with common pin) 4 = analogue output 0(4)-20 mA, 0(2)-10 V 5 = 2 Photo-Mos relay switch (0.2 A) 6 = 1 semiconductor relay TRIAC (1A) 7 = 1 power supply 4.85 V (e. g. for ISFET sensor) 8 = 1 power supply 12 V _{DC} (e. g. for inductive proximity switch) S = Interface RS 422/485 D = Data logger with interface RS 485 ¹⁾ P = Interface Profibus DP	0 = without (factory set) Y = adjusted according to customer specification

¹⁾ The readout of data is only possible with the PC setup software! Note: All languages are available in the device menu and can be changed by the customer at any time. The factory default setting of a language (except for "German") entail additional costs.

..

3 Instrument identification

3.3 Accessories (included in delivery)

- 4 x fastening elements, complete¹
- 3 x CON plug-in link¹
- 3 x jumper wire²
- 1 x seal for panel¹
- 1 x fastening elements, complete²
 - 1 x DIN rail fastening left
 - 1 x DIN rail fastening right
 - 3 x wall mount
 - 3 x fastening screw

¹ For basic type extension 01 only (in the panel enclosure)

² For basic type extension 05 only (in the surface-mounted enclosure)

3.4 Accessories (optional)

Type	Sales No.
Holder for C rail	ACM-Halt
PC setup software	ACM-Soft
PC interface cable including USB/TTL converter and two adapters (USB connecting cable)	ACM-Int

Optional board	Code	Sales No.
Analog input (universal)	1	APM-1000001
Relay (1 x changeover)	2	APM-1000002
Relay (2 x NO)	3	APM-1000003
Analog output	4	APM-1000004
Two MosFET semiconductor switches	5	APM-1000005
Semiconductor relay 1 A	6	APM-1000006
Supply voltage output +/- 5 V DC (e.g. for ISFET)	7	APM-1000007
Supply voltage output 12 V DC (e.g. for inductive proximity switch)	8	APM-1000008
Interface - RS422/485	10	APM-100000S
Datalogger with RS485 interface	11	APM-100000D
Profibus-DP interface	12	APM-100000P

4 Assembly

4.1 General

Mounting location

Find a location that ensures easy accessibility for the later calibration.
The fastening must be secure and must ensure low vibration for the instrument.

Avoid direct sunlight!

Permissible ambient temperature at the installation location: -10 - 55°C with max. 95% rel. humidity, no condensation.

Installation position

The instrument can be mounted in any position.

4.2 Dimensions

4.2.1 Panel mounting

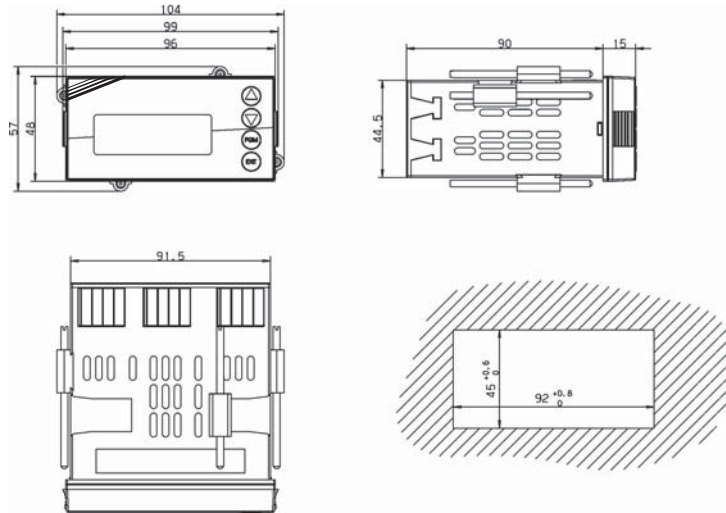

Close mounting

Minimum spacing of panel cutouts	Horizontal	Vertical
Without setup connector:	30mm	11mm
With setup connector (see arrow):	65mm	11mm

4.2.2 Field housing

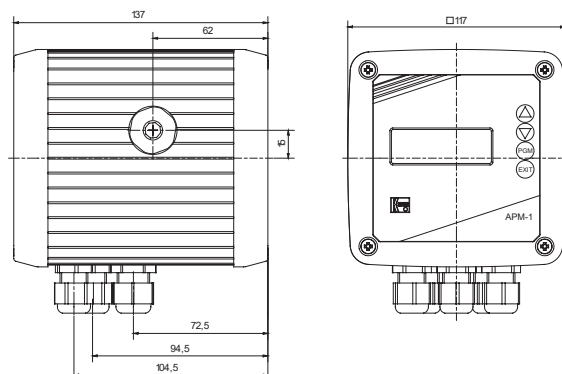

5.1 Installation instructions



The electrical connection must only be performed by qualified personnel!

- The choice of cable, the installation and the electrical connection must conform to the requirements of VDE 0100 “Regulations on the Installation of Power Circuits with Nominal Voltages below 1000 V” and the relevant local regulations
- If contact with live parts is possible when working on the device, it must be completely disconnected from the electrical supply.
- The load circuits must be fused for the maximum load currents in each case to prevent the relay contacts from becoming welded in the event of a short circuit.
- Electromagnetic compatibility meets the requirements of EN 61326.
- Lay the input, output, and supply lines so they are physically separated from each other and are not parallel.
- Use twisted and shielded probe cables. If possible, do not lay these cables close to components or cables through which current is flowing. Ground the shielding at one end.
- The probe cables must have an uninterrupted run (do not route them via terminal blocks or similar arrangements).
- No other consumers can be connected to the power terminals of the instrument.
- The instrument is not suitable for installation in areas with an explosion hazard.
- Apart from faulty installation, incorrect settings on the instrument may also affect the proper functioning of the subsequent process or lead to damage. You should therefore always provide safety equipment that is independent of the instrument and it should only be possible for qualified personnel to make settings.

Mounting information for conductor cross-sections and ferrules

Ferrule	Conductor cross-section		Minimum length of ferrule or stripping
	Minimum	Maximum	
Without ferrule	0.34 mm ² .	2.5 mm ² .	10mm (stripping)
Without collar	0.25 mm	2.5 mm ² .	10mm
With collar up to 1.5 mm ²	0.25 mm ² .	1.5 mm ² .	10mm
Twin, with collar	0.25 mm ² .	1.5 mm ² .	12mm

5 Installation

5.2 Electrical isolation

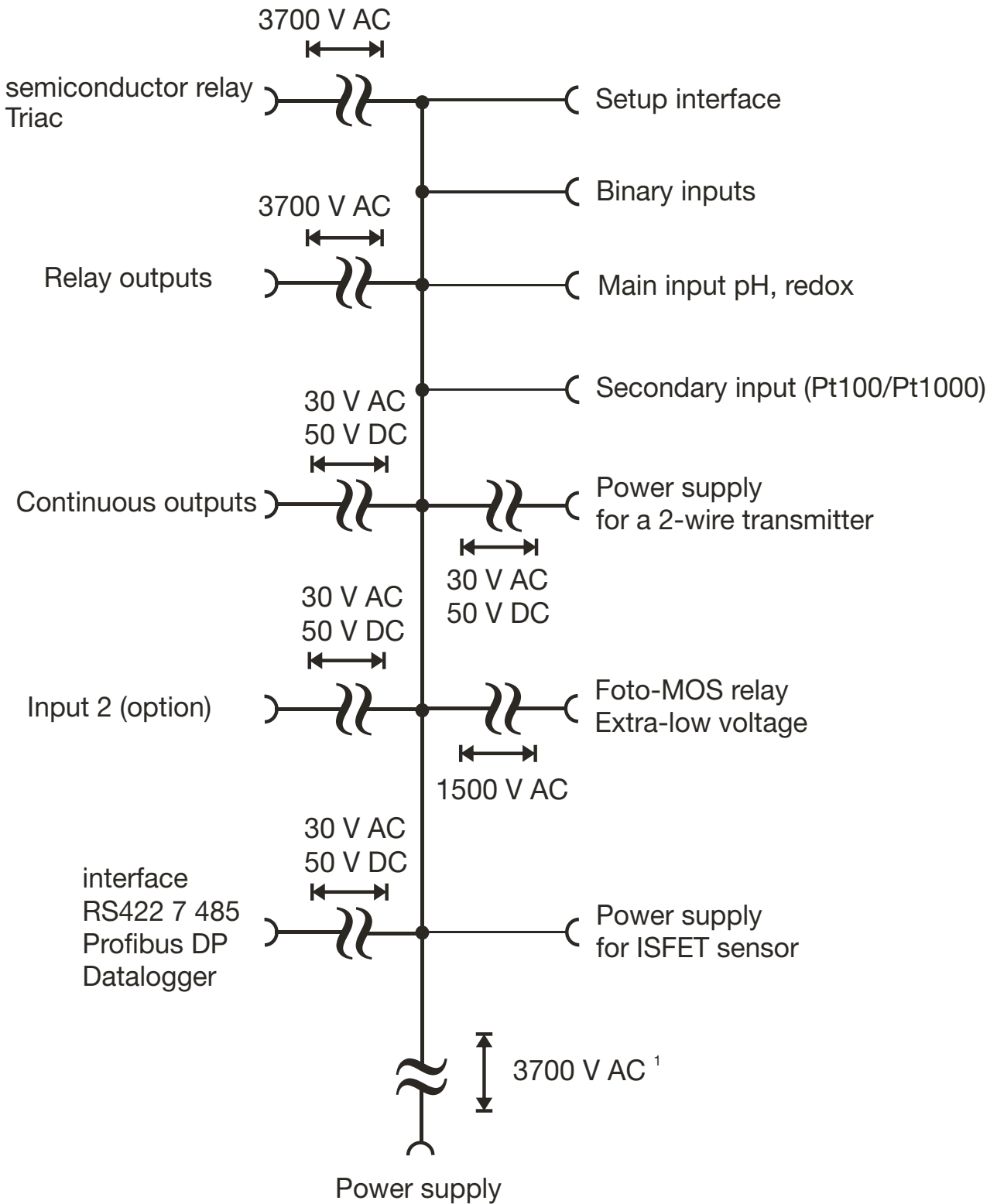

5.3 Connection

5.3.1 Terminal assignment

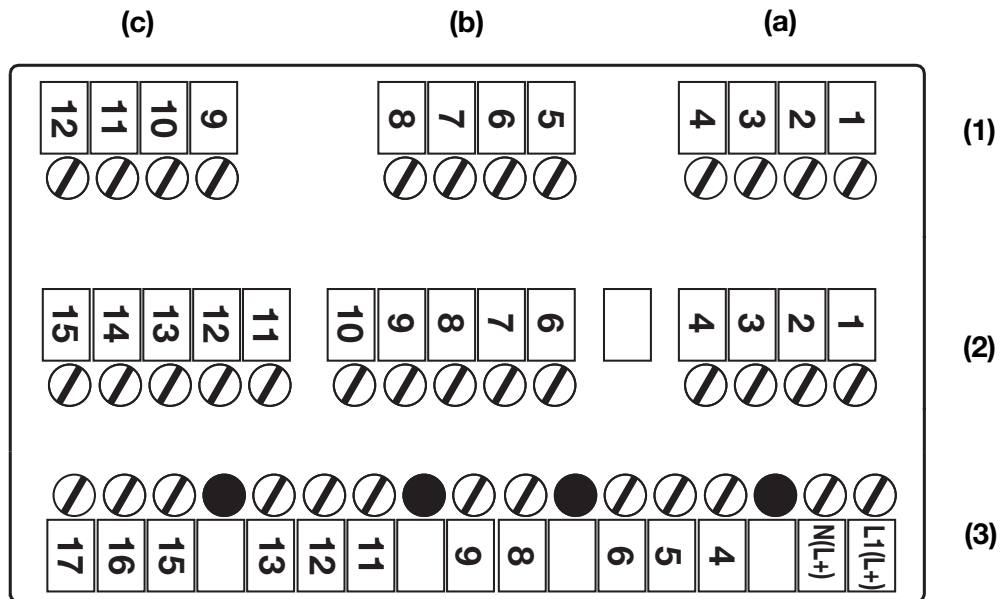





















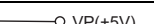









(1)	Row 1	(a)	Option 1	(b)	Option 2	(c)	Option 3	
(2)	Row 2	Main input board (pH / redox / temperature / standard signal)						
(3)	Row 3	PSU board (power supply / 2x relays)						

5.3.2 Optional board (row 1, slot a, b or c)

Function	Symbol	Terminal for slot (a)	Terminal for slot (b)	Terminal for slot (c)
Analog input				
Temperature sensor in a two-wire circuit Pt100 or Pt1000		2	6	10
		4	8	12
Temperature sensor in a three-wire circuit Pt100 or Pt1000		2	6	10
		3	7	11
		4	8	12
Resistance transmitter		2	6	10
		3	7	11
		4	8	12
		E		
		S		
		A		
Electrical current		3	7	11
		4	8	12

5 Installation

Function	Symbol	Terminal for slot (a)	Terminal for slot (b)	Terminal for slot (c)
Voltage 0(2) - 10 V		1	5	9
		2	6	10
Voltage 0 - 1 V		2	6	10
		3	7	11
Continuous output				
Current or voltage		2	6	10
		3	7	11
Modbus interface				
RS422		1	5	9
		2	6	10
		3	7	11
		4	8	12
RS485		3	7	11
		4	8	12
Profibus interface				
		1	5	9
		2	6	10
		3	7	11
		4	8	12
Data logger interface				
RS485		2	6	10
		3	7	11
Relay (1x changeover)				
		K3 1	K4 5	K5 9
		2	6	10
		3	7	11
Relay (2x NO, common pin)				
		K3 1		K5 9
		2		10
		K6 3		K8 11
Triac (1 A)				
		K3 2	K4 6	K5 10
		3	7	11
Foto-MOS relay (0.2 A)				
		K3 1	K4 5	K5 9
		2	6	10
		K6 3	K7 7	K8 11
		4	8	12

5 Installation

Function	Symbol	Terminal for slot (a)	Terminal for slot (b)	Terminal for slot (c)
Power supply for ISFET sensor				
DC +/- 5 V		1	5	9
GND		2	6	10
		3	7	11
		4	8	12
DC +12 V		1	5	9
GND		2	6	10

5.3.3 Main board (row 2)

Function	Symbol	Terminal
Power supply for ISFET sensor		
DC +/- 4.85 V		11
GND		10
		15
Standard signal input for electrical current		
0(4) - 20 mA		3
		4
Standard signal input for voltage		
0(2) - 10 V or 10 - 0(2) V		1
		4
Temperature sensor in a two-wire circuit		
Pt100 or Pt1000		2 3 4
Temperature sensor in a three-wire circuit		
Pt100 or Pt1000		2 3 4
Resistance transmitter		
		4 3 2
pH/redox electrode		
Shield for pH (with triaxial cable only!)		6
Glass/metal electrode		7
Reference electrode		8
Liquid potential (LP) With asymmetrical connection, bridge between terminal 8 and 9 With symmetrical connection, LP on terminal 9		9

5 Installation

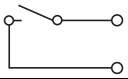
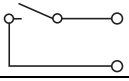
Binary inputs		
Binary input 1		12+ 14
Binary input 2		13+ 14

5.3.4 PSU board (row 3)

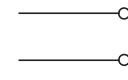
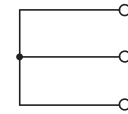
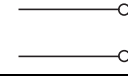
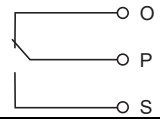
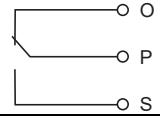
Function	Symbol	Terminal
Power supply for APM-1		
Power supply: AC 110 - 240 V		1 L1 (L+) 2 N (L-)
Power supply: AC/DC 20 - 30 V		
n.c.		4 5 6
Supply voltage for external 2-wire transmitter		
24 V DC (-15 / +20%)		8 L + 9 L -
Relay 1		
Switching output K1 (floating)		11 12 13
Relay 2		
Switching output K2 (floating)		15 16 17



Operation via the instrument keypad is described below.

Instrument operation via the optional set-up program, See section 14 "Setup program", page 88.

6.1 Controls



- (1) Measurement unit
- (2) Temperature
- (3) Operating mode
- (4) Measured value
- (5) ▲ key Increase numerical value / Forward selection
- (6) ▼ key Decrease numerical value / Forward selection
- (7) PGM key Change level / Forward selection / Confirm selection
- (8) EXIT key Cancel entry / Exit level

6 Operation

6.2 Display

6.2.1 Measuring mode (normal display)

Example

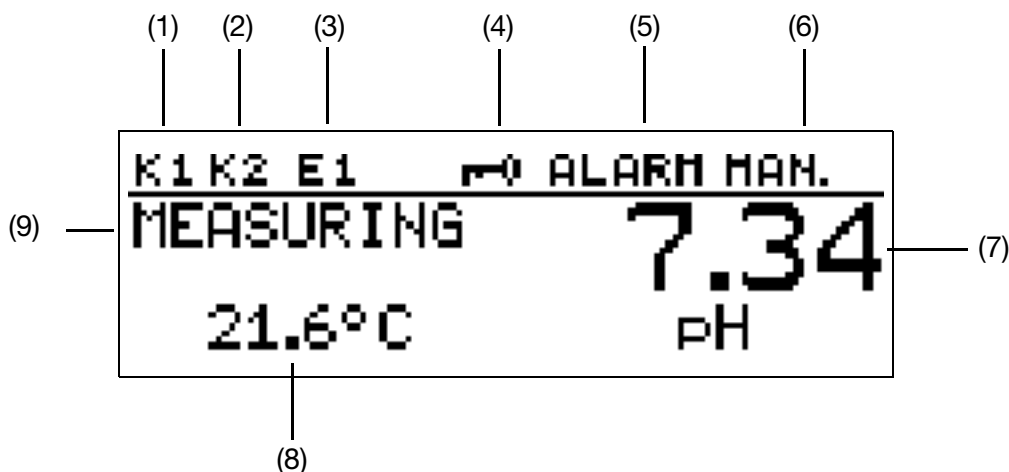

- (1) Binary output (relay) K1 is active
- (2) Binary output (relay) K2 is active
- (3) Binary input is active
- (4) Keypad is locked
- (5) Instrument status
 - ALARM (flashing): Broken sensor or overrange, etc.
 - AL R1: Controller monitoring alarm from controller channel 1
 - AL R2: Controller monitoring alarm from controller channel 2
 - CALIB: Calibration mode active
 - CALIB (flashing): Calibration timer elapsed
- (6) Output mode
 - MAN.: Manual mode and/or simulation mode active
 - HOLD: Hold mode active
- (7) Top display
 - Measured value and unit of the variable set by parameter "Top display"
- (8) Bottom display
 - Measured value and unit of the variable set by parameter "Bottom display"
- (9) Operating mode
 - MEASURING: Standard measuring mode is active



To return to measuring mode (MEASURING):
Press the  key or wait for a "timeout".

6.3 Principle of operation

6.3.1 Operation in levels

	See page
Measurement mode	
Normal display	26
Min/max values of the main input	28
Min/max values of the optional inputs	29
Output display	29
Current values of the main input	29
Current values of the input options	30
Current values of the math channels	30
States of the binary inputs and outputs	30
Manual mode overview	31
Hardware information	31
Instrument information	32
User data	89
Calibration (depending on the basic setting)	46, 55, 60, 63
Manual mode / simulation	35
Hold mode	37
Main menu	
User level	32
Input pH/redox	112
Input temperature	112
Optional inputs	113
Analog input 1, 2, 3	
Binary inputs	114
Binary input 1, 2	
Controllers	115
Controller 1	
Parameter set 1, 2	
Configuration	
Controller 2	
Parameter set 1, 2	
Configuration	
Controller special functions	117
Limit value control	117
Limit value 1, 2, 3	
Binary outputs	114
Binary output 1, 2, 3, ... 8	
Analog outputs	119
Analog output 1, 2, 3	
Interface	120
Wash timer	120
Datalogger	120

6 Operation

Display	121
Administrator level (password)	33
Parameter level	33
Parameters as above for "User level"	
Release level	33
Parameters as above for "User level"	
Basic setting	33
Calibration level	35
Main input (depending on the basic setting)	
Zero point	
2-point	
3-point	
Optional input 1, 2, 3	
Temperature coefficient, linear	
Temperature coefficient, curve	
Relative cell constant	
Zero point	
Limit point	
2-point	
Calibration release	35
Main input (depending on the basic setting)	
Temperature coefficient, linear	
Temperature coefficient, curve	
Relative cell constant	
Zero point	
Limit point	
2-point	
3-point	
K factor	
Optional input 1, 2, 3	
Temperature coefficient, linear	
Temperature coefficient, curve	
Relative cell constant	
Zero point	
Limit point	
2-point	
3-point	
Delete min/max values	35
Main input	
Optional input 1, 2, 3	
Delete logbook	35
Main input	
Optional input 1, 2, 3	
Delete daily batch	35

6 Operation

	Delete total batch	35
	Calibration level	46, 55, 60
	Main input	
	Zero point	
	2-point	
	3-point	
	Optional input 1, 2, 3	113
	Temperature coefficient, linear	
	Temperature coefficient, curve	
	Relative cell constant	
	Zero point	
	Llimit point	
	2-point	
	Calibration logbook	79
	Main input	
	Optional input 1, 2, 3	
	Instrument information	32

6 Operation

6.4 Measuring mode



Different display types can be configured, See "Display of measured values STANDARD" page 104.

To return to measuring mode:
press the **EXIT** key or wait for a "timeout".

Measurements with "out of range" are ignored.

The min./max. value memory can be reset:
Administrator level / Delete min/max.

When the basic setting is changed, the min and max values are deleted.

6.4.1 Normal display

Visualization

The following are displayed in measuring mode:

- Analog input signal
- Unit (for example pH)
- Temperature of the sample medium

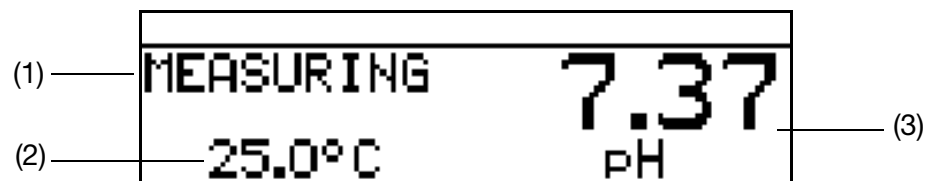

- (1) MEASURING -> Measuring mode
- (2) 25.0°C -> Temperature of the sample medium
- (3) 7.70 pH -> Measurement value calculated from the standard signal at the input

6.5 Input/output information

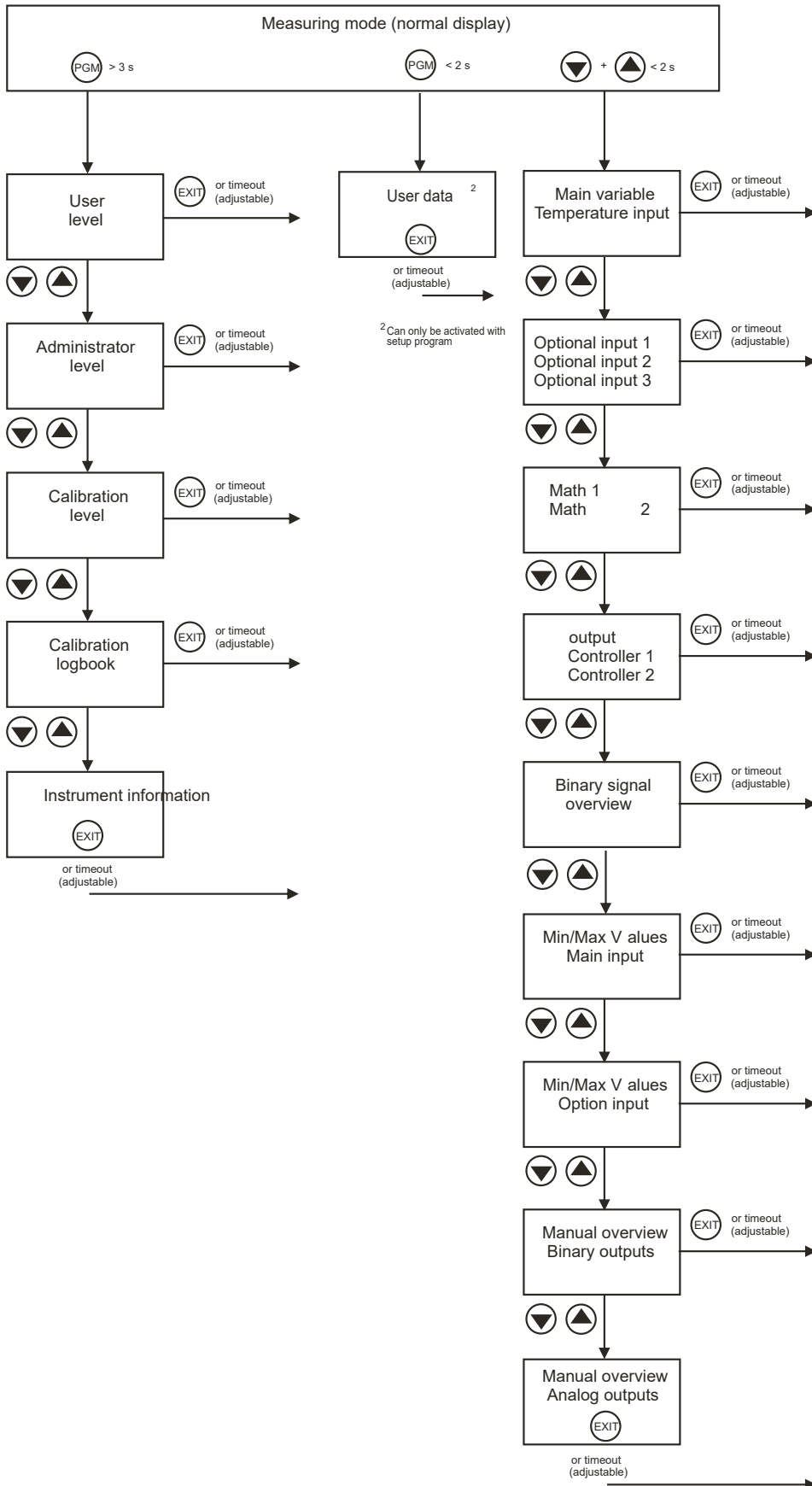

6 Operation

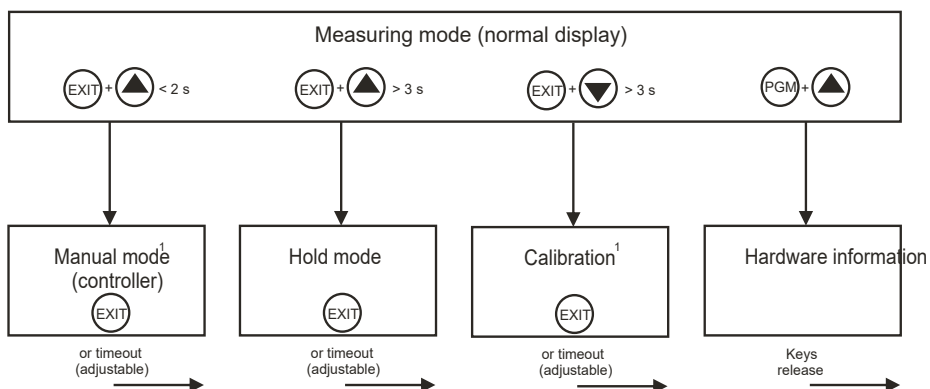

¹ Only if released

6.5.1 User data

```
SP 1 Reservoir II
7.03 pH
```

Up to 8 parameters that are frequently changed by the user can be combined in the user level under "User data" (via setup program only).

Activating the display

The instrument is in measuring mode (normal display)

- * Briefly press the PGM key.
- * Select the required "quick setting" with the \blacktriangle and \blacktriangledown keys.

Editing

- * Briefly press the PGM key.
- * Edit the setting with the \blacktriangle and \blacktriangledown keys.

6.5.2 Min/max values of the main input

```
MIN/MAX MAIN INP.
1: 5.03 8.52 pH
T: 25.0 25.0 °C
```

Activating the display

The instrument is in measuring mode (normal display)

- * Briefly press the \blacktriangle or \blacktriangledown key (several times if necessary).
Minimum and maximum values of the main value "1:" (pH, mV, %, ppm) and

temperature "T:" are displayed.

The extreme values of the main measurement variable and the temperature are **not** mutually assigned (for example not 5.03 pH for 25.0°C).

6.5.3 Min/max values of the optional inputs

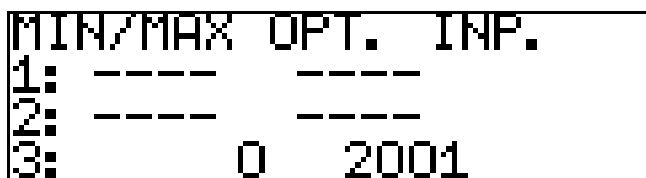

```
MIN/MAX OPT. INP.  
1:  -----  
2:  -----  
3:           0   2001
```

Activating the display

The instrument is in measuring mode (normal display)

- * Briefly press the ▲ or ▼ key (several times if necessary).
Minimum and maximum values of the optional inputs (1, 2 and 3) are displayed

6.5.4 Output level

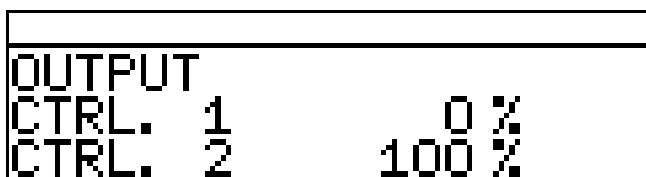

```
OUTPUT  
CTRL. 1   0 %  
CTRL. 2  100 %
```

Activating the display

The instrument is in measuring mode (normal display)

- * Briefly press the ▲ or ▼ key (several times if necessary).
The current output levels of the controller outputs.

6.5.5 Current values of the main entries

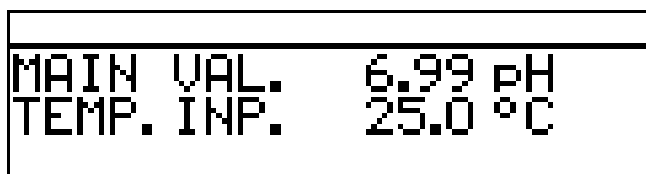

```
MAIN VAL.  6.99 pH  
TEMP. INP. 25.0 °C
```

Activating the display

The instrument is in measuring mode (normal display)

- * Briefly press the or ▼ key (several times if necessary).
The current values of the main output are displayed.

6 Operation

6.5.6 Current values of the optional entries

OPT.	IN	1	0
OPT.	IN	2	0
OPT.	IN	3	0

Activating the display

The instrument is in measuring mode (normal display)

- * Briefly press the ▲ or ▼ key (several times if necessary).
The current values of the optional inputs (1, 2 and 3) are displayed.

6.5.7 Current values of the math channels

MATHS	1	8888
MATHS	2	8888

Activating the display

The instrument is in measuring mode (normal display)

- * Briefly press the ▲ or ▼ key (several times if necessary).
The current values of the main output are displayed.

6.5.8 States of the binary inputs and outputs

OVERVIEW BIN. SIG.							
E1	0	E2	0				
K1	⊙	K2	0	K3	0	K4	0
K5	0	K6	0	K7	0	K8	0

Activating the display

The instrument is in measuring mode (normal display)

- * Briefly press the ▲ or ▼ key (several times if necessary).
The states of binary inputs E1 and E2 and of relays K1 through K8 are displayed. In the example shown here, relay K1 is active.

6.5.9 Manual mode overview

Analog outputs (optional boards)

In this example, analog outputs 2 and 3 are working normally.

```
MANUAL OVERVIEW
ANALOG INPUT 1  MAN.
ANALOG INPUT 2  ----
ANALOG INPUT 3  ----
```

Switching outputs (PSU board and optional boards)

In this example relay output 2 is in manual mode.

```
MANUAL OVERVIEW
BINARY OUTPUTS
K1 0 K2 @ K3 0 K4 0
K5 0 K6 0 K7 0 K8 0
```

The instrument is in "normal display" mode

* Briefly press the ▲ or ▼ key (several times if necessary).



Manual mode can only be displayed if at least one output is in manual mode. For example Administrator level / Parameter level / Binary outputs / Binary output 1 / Manual mode "Active" or "Simulation".

To return to measuring mode:
press the **EXIT** key or wait for a "timeout".

6.5.10 Hardware info



These displays are required for phone support.

The instrument is in measuring mode (normal display)

* Press and hold the **PGM** and ▲ keys.

```
MAIN CPU 268.01.01-34
MAIN INPUT 269.01.01-04
```

Alternating display



6 Operation

```
OPTION 1      200.01.02
OPTION 2
OPTION 3      193.02.01
BOOTLOADER    297.00.01
```

6.5.11 Device info







These displays provide an overview of fitted hardware options and the settings of inputs (helpful for troubleshooting, etc.).

- * Press the  key for longer than 3 seconds.
- * Briefly press the  or  key (several times if necessary).
- * Select Device info

```
ADMINISTR. -LEVEL >
CALIBR. -LEVEL >
CALIBR. -LOGBOOK >
DEVICE INFO >
```

- * Press the  keys.

```
MAIN INP.  PH/REDOX
OPTION 1:  ANALOGOUT
OPTION 2:  ANALOG IN
OPTION 3:  DATALOG.
```

- * Briefly press the  or  key (several times if necessary).
For further information about the inputs, press the  or  keys.

6.6 User level

All the parameters that the Administrator (See section 6.7 "Administrator level", page 33) has released can be edited at this level. All the other parameters (marked by a key ) are read only.

- * Press the  key for longer than 2 seconds.
- * Select "USER LEVEL".

```
USER LEVEL >
ADMINISTR. -LEVEL >
CALIBR. -LEVEL >
CALIBR. -LOGBOOK >
```

All possible parameters are accessed below. Depending on the configuration of a specific instrument, some of these parameters may not appear.







6.6.1 Parameters of the User level

See section 18.2 "Parameters of the User level", page 112.

6.7 Administrator level

- All the parameters can be edited at this level.
- At this level, it is also possible to define which parameters can be edited by a "normal" user (operator) and which calibrations can be performed.

To get to the Administrator level, proceed as follows:

- * Press the  key for longer than 2 seconds.
- * Use the  or  keys to select "ADMINISTR. LEVEL".
- * Use the  and  keys to enter the password 300 (factory setting).
- * Confirm the  key.

6.7.1 Parameter level

The settings that can be made here are the same as those at the User level, See "User level" page 32. As the operator (user) has administrator rights here, the parameters that are locked in the User level can now also be modified.

6.7.2 Release level

All parameters can be released (modification possible) or locked (no modification possible) for editing at operator level.

6.7.3 Basic settings

The APM-1 has a basic setting wizard, to make it easier for the user to configure the extensive setting options of the instrument and to avoid configuration conflicts.

The basic settings are reached via ADMINISTR. LEVEL / PASSWORD / BASIC SETTING.

All the important settings are systematically polled here. At the end, once a request for conformation has been acknowledged, the instrument is initialized with the new settings. Dependent parameters are checked and adjusted.

Basic setting wizard

6 Operation

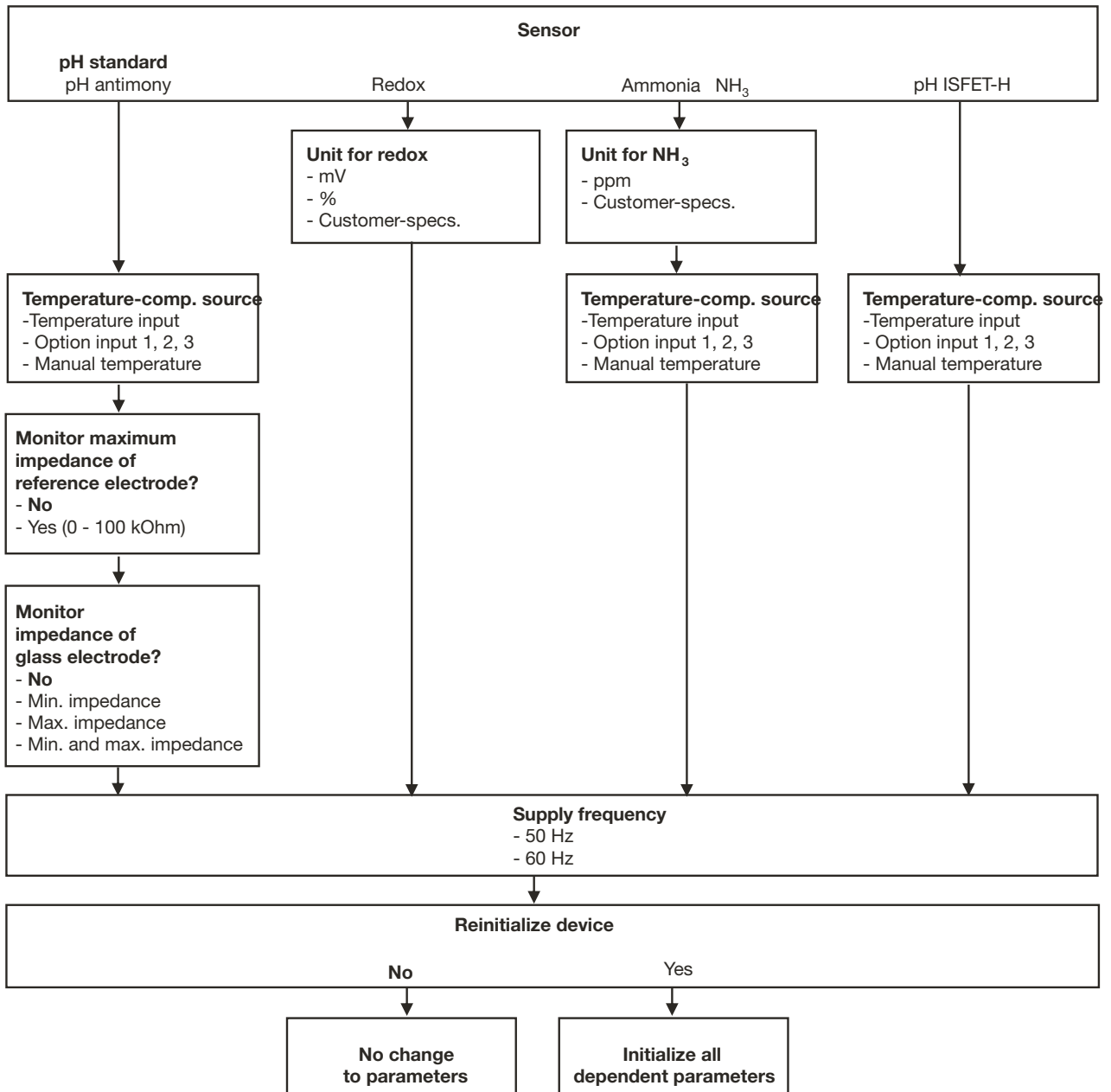

6.7.4 Calibration level

Depending on which operating mode has been configured (in the Basic setting menu), one or more of the following calibration options will be available:

- Zero point
- 2-point calibration (only with setting "pH STANDARD" and "pH ANTIMONY")
- 3-point calibration (only with setting "pH STANDARD" and "pH ANTIMONY")

6.7.5 Calibration release

Which calibration procedure may be performed directly and which may not can be configured here, See section 8.2.2 "Ways to start the calibration", page 47.

6.7.6 Delete min/max values

If required, the values can be deleted once a request for confirmation has been acknowledged.

See "Min/max values of the main input" page 28 or

See "Min/max values of the optional inputs" page 29.

6.7.7 Delete logbook

The last five calibration processes for each input are archived in the calibration logbook. If a "Datalogger" optional board is fitted, the date and time are also archived.

If necessary the logbook can be deleted after a confirmation prompt.

6.7.8 Delete daily batch

If required, the counter can be deleted once a request for confirmation has been acknowledged.

6.7.9 Delete total batch

If required, the counter can be deleted once a request for confirmation has been acknowledged.

6.8 MANUAL mode / Simulation mode

These functions can be used to set the switching outputs and analog outputs of the instrument manually to a defined state. This facilitates dry startup, troubleshooting and customer service. ▲

Simulation mode accesses the analog outputs and binary outputs **directly**. When simulation mode has been selected, MANUAL mode is **not** possible!

In MANUAL mode the settings for "higher order controllers" are taken into consideration.

6 Operation

6.8.1 MANUAL mode only via "higher order" controller functions

Select manual mode



In the factory setting of the instrument the MANUAL mode parameter is locked and can **only be activated by the administrator!**

This parameter must first be released for other users, See "Release level" page 33.

- * Set ADMINISTR. LEVEL / PARAMETER LEVEL / CONTROLLER / CTRL.SPEC. FUNCT. / MANUAL MODE "Locked, **Coding** or **Switching**.



Locked = No Manual mode, control is via device.

Coding = The outputs are active as long as the ▼ or ▲ key is pressed.

Switching = the outputs are active if the ▼ or ▲ key is pressed. If the corresponding key is pressed again, the output becomes inactive again.



Activate Manual mode

The instrument is in Display mode

- * Press the  and  keys for less than 2 seconds.
The word MANUAL appears in the status line of the display.



If the  keys (alone) are pressed for longer than 3 seconds, the instrument switches to language selection!

If the  and  keys are pressed for longer than 3 seconds, the instrument goes into HOLD mode.

Then the outputs of the instrument respond according to the default settings.

To exit HOLD mode, press the  and  keys for longer than 3 seconds.

Control is not longer via the instrument. The output level of the controllers is 0%.

Controller 1 is activated by the  key. In this case the output level of controller 1 is 100%.

Controller 2 is activated by the  key. In this case the output level of controller 2 is 100%.

Deactivation

- * Press the  key.

Control is once again through the outputs of the instrument.
The word MANUAL appears in the status line of the display.

6.8.2 Simulation of binary outputs

Activate simulation



In the factory setting of the instrument the MANUAL mode parameter is set to "No simulation" and can **only be activated by the administrator!**

This parameter must first be released for other users, See "Release level" page 33.

If a higher order switching function has been assigned to an output, Simulation mode is not possible for that output.

* Set ADMINISTR. LEVEL / PARAMETER LEVEL / BINARY OUTPUTS / BINARY OUTPUT1(...8) "Manual mode no simulation, **Inactive** or **Active**".

No simulation = No Manual mode, control is via device.

Inactive = Relay K1 or K2 is de-energized; the word MANUAL appears in the status line of the display

Active = Relay K1 or K2 is energized; the word MANUAL appears in the status line of the display

Deactivate manual mode

No simulation = No Manual mode, control is via device.

When the instrument is in display mode, the word MANUAL disappears from the status line of the display.

6.8.3 Simulation of analog outputs via MANUAL mode

Release and activation

* Select activation of simulation of the actual value output:
ADMINISTR. LEVEL / PARAMETER LEVEL / ANALOG OUTPUTS / ANALOG OUTPUT 1 (2, 3) / SIMULATION / ON.

With "On" the output takes on the value of the "Simulation value" parameter.

When the instrument is in display mode, the word MANUAL appears in the status line of the display.

Deactivation

* ADMINISTR. LEVEL / PARAMETER LEVEL / ANALOG OUTPUTS / ANALOG OUTPUT 1 (2, 3) / SIMULATION / OFF.

The corresponding output of the instrument works again.

When the instrument is in display mode, the word MANUAL disappears from the status line of the display.

6.9 HOLD mode

In HOLD status the outputs take on the states programmed in the relevant parameter (controller channel, switching output or analog output).

This function can be used to "freeze" switching outputs and the analog

6 Operation

outputs of the instrument. This means the current status of the output will be retained even when the measured value changes. Control is not via the instrument.





If MANUAL mode is activated while HOLD mode is activated, MANUAL mode takes precedence and MANUAL then appears in the status line of the display! MANUAL mode can be terminated by pressing the  key.

If HOLD mode is still activated (by the binary input or by keyboard), the instrument then returns to HOLD mode!



HOLD mode can be activated by pressing the key or by the binary input.

Activation by pressing key

* Press and hold the  and  keys longer than 3 seconds. Then the outputs of the instrument respond according to the default settings.

The word HOLD appears in the status line of the display.





If the  and  keys are pressed for less than 3 seconds, the instrument goes into Manual mode.

Then the outputs of the instrument respond according to the default settings.

Pressing a key to deactivate HOLD mode

* Press the  and  keys for longer than 3 seconds.



If the  and  keys are pressed for less than 3 seconds, the instrument goes into Manual mode.

Then the outputs of the instrument respond according to the default settings.

Control is through the outputs of the instrument again. The word MANUAL disappears from the status line of the display.

7 Commissioning

7.1 Getting started



Some suggestions follow for configuring the instrument reliably in little time.

- * Mount the instrument, See section 4 "Assembly", page 14.
- * Install the instrument, See section 5 "Installation", page 15 ff.
- * Call up Administrator level (ADMINISTR. LEVEL).
- * Enter password 0300 (factory setting).
- * Call up PARAMETER LEVEL / DISPLAY / OPERAT. TIMEOUT.
- * Set OPERAT. TIMEOUT to 0 minutes (no timeout).
- * Leave the Display level with "EXIT"
- * Leave the Parameter level with "EXIT"
- * Select BASIC SETTING and work through all the menu items, See section 6.7.3 "Basic settings", page 33.
- * Answer "YES" to the "Reinitialize device" query
- * Configure the required additional parameters.
- * Calibrate the instrument to the sensor and sample medium,
See section 8 "Calibrating a pH measurement chain", page 46 or
See section 9 "Calibrating a redox measurement chain", page 55 or
See section 10 "Calibrating an ammonia measuring cell", page 60 or
See section 11 "Calibrating a sensor with a standard signal", page 63.

7.2 Setting examples

7.2.1 Measuring the pH value with pH combination electrode



pH measurement with automatic temperature compensation.

Layout

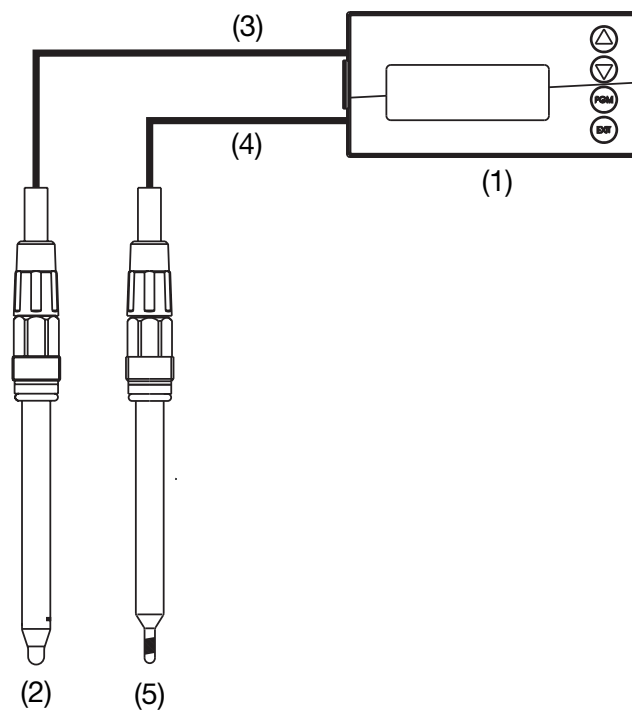

- (1) Transmitter/controller type APM-1
- (2) pH combination electrode on the main board
- (3) Coaxial cable
- (4) Two-wire shielded cable
- (5) Compensation thermometer Pt100 on the main board

Electrical connection

See section 5 "Installation", page 15.

Task

Measuring range:	2 - 12 pH
Output signal:	4 - 20 mA
Temperature measurement	Pt100
Control function:	Pulse width controller
Setpoint 1:	pH 6.5
Setpoint 2:	pH 8.5

7 Commissioning

Basic setting



Start the basic settings See section 6.7.3 "Basic settings", page 33
Diagrammatic overview, See section "Basic setting wizard", page 33.

Sensor	pH standard
Temperature compensation source	Temperature input
Reference monitoring	Off
Glass electrode monitoring	Off
Supply frequency	50 Hz
Reinitialize device	Yes

Temperature input

Administrator level / Password / Parameter level / Temperature input

Temperature sensor	Pt100
--------------------	-------

Analog output

Administrator level / Password / Parameter level / Analog outputs / Analog output 1

Signal source	Main variable
Signal type	4 - 20 mA
Start of scaling	2.00 pH
End of scaling	12.00 pH

Controller settings

See section 13.6.2 "Controller with PID behavior and pulse length output", page 86.

7.2.2 pH differential measurement



Both pH measurements are automatically temperature compensated.

Layout

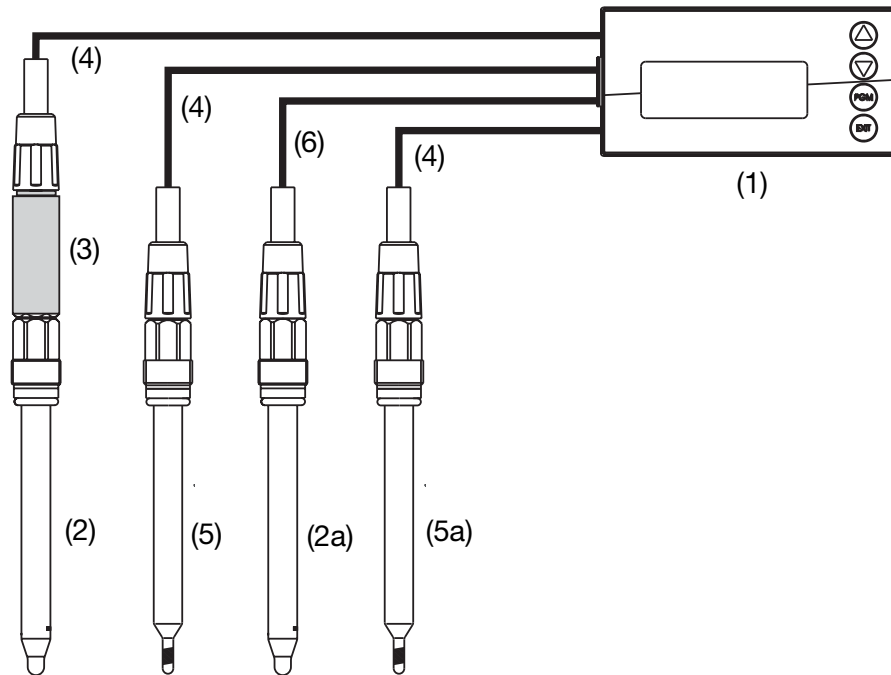

- (1) Transmitter/controller type APM-1
- (2) pH combination electrode with 2-wire transmitter
- (2a) pH combination electrode on main board
- (3) Two-wire transmitter on optional board 1
- (4) Two-wire shielded cable
- (5) Compensation thermometer Pt100 on optional board 2
- (5a) Compensation thermometer Pt100 on main board
- (6) Coaxial cable

Electrical connection

See section 5 "Installation", page 15.

Task

Measurement range (main board): 2 - 12 pH
Measurement range (optional board): 2 - 12 pH
Output signal (main board): 4 - 20 mA
Temperature measurements Pt100
Actual value for the controller: main board

7 Commissioning

Limit value control:	limit value function
Limit value 1:	pH 6.5
Limit value 2:	pH 8.5

Basic setting of main board



Start the basic settings See section 6.7.3 "Basic settings", page 33
Diagrammatic overview, See section "Basic setting wizard", page 33.

Sensor	pH standard
Temperature compensation source	Temperature input
Reference monitoring	Off
Glass electrode monitoring	Off
Supply frequency	50 Hz
Reinitialize device	Yes

Input for main board temperature

Administrator level / Password / Parameter level / Temperature input
Temperature sensor Pt100

Analog output of main board

Administrator level / Password / Parameter level / Analog outputs / Analog output 1
Signal source Main variable
Signal type 4 - 20 mA
Start of scaling 2.00 pH
End of scaling 12.00 pH

Basic setting for optional board 1

Administrator level / Password / Parameter level / Optional inputs / Analog input 1
Operating mode pH measurement
Signal type 4 - 20 mA
Start of scaling -600 mV (depending on the two-wire transmitter)
End of scaling +600 mV (depending on the two-wire transmitter)
Temperature compensation source Optional input 2

7 Commissioning

Basic setting for optional board 2

Administrator level / Password / Parameter level / Optional inputs / Analog input 2

Operating mode	Temperature
Signal type	Pt100
Connection type	2-wire

Controller settings

See section 13.6.1 "Simple limit monitoring", page 85.

8 Calibrating a pH measurement chain

8.1 Notes



During calibration, relays and analog output signals adopt their configured states!



When is calibration required?

- At regular intervals (depending on the sample medium and requirements).
- If negative values appear in the top display.
- If the top display indicates "Underrange / Overrange".

Every successfully completed calibration is documented in the calibration logbook, see section 12 "Calibration logbook", page 79.

8.2 General information

The electrical properties of all sensors vary slightly from instance to instance and also change during operation (due to deposits or wear, etc.). This causes the output signal of the sensor to change.

The transmitter uses a typical, concentration-dependent characteristic to measure ammonia with "normal" accuracy requirements. The individual properties of the sensor are taken into account here by offsetting the zero point. This considerably reduces the effort required for calibration.

The transmitter software is specially adapted for coolant monitoring.

8.2.1 Requirements

- The instrument must be supplied with voltage, see section 5 "Installation", page 15 ff.
 - A combination electrode must be connected to the transmitter.
-



For a configuration example see section 7.2.1 "Measuring the pH value with pH combination electrode", page 41.

A pH sensor can be connected to the optional board

- connected directly to the main input or
 - connected to the "Analog input (universal)" optional board via a 2-wire transmitter.
-

- "PH STANDARD" must be configured as sensor in the basic setting.
 - The instrument is in Measurement mode.
-

8 Calibrating a pH measurement chain

8.2.2 Ways to start the calibration





Select the input to which the pH sensor is connected.



If Calibration level is not released

- Press the  key for longer than 3 seconds / ADMINISTR. LEVEL / PASSWORD / CALIBR. LEVEL / MAIN INPUT or ANALOG INPUT.

If Calibration level is released

- Press the  and  keys simultaneously / MAIN INPUT or ANALOG INPUT.

If Calibration level is released

- Press the  key for longer than 3 seconds / CALIBR. LEVEL / MAIN INPUT or ANALOG INPUT.

8.2.3 Calibration options

The instrument provides two calibration options for adapting the APM-1 to a pH combination electrode:

One-point offset calibration

The zero point of the pH combination electrode is calibrated, see section 8.3 "Zero point (1-point) calibration", page 48.
Recommended only for special applications, such as ultra-pure water.

Two-point calibration

The zero point and slope of the combination electrode are calibrated, see section 8.4 "2-point calibration", page 49.
This is the recommended calibration for most sensors.

Three-point calibration

In three-point calibration, the zero point and the slope are calibrated in the acidic range and the slope is calibrated in the alkaline range, see section 8.4 "2-point calibration", page 49.
This calibration is recommended with heightened requirements for accuracy.

8 Calibrating a pH measurement chain

8.3 Zero point (1-point) calibration

- * Make preparations, see section 8.2 "General information", page 46 .
- * Start calibration, see section 8.2.2 "Ways to start the calibration", page 47.
- * Select zero point calibration.

ZERO POINT	>
2-POINT	>
3-POINT	>



- * Immerse the combination electrode in a buffer solution with a known pH value.
- * Start the zero point calibration with the  key.



Now the source of temperature acquisition can be selected (manually, or using the temperature input of the basic board, or the temperature input via the optional board). This source will be active for the duration of the calibration.

An example follows: Manual temperature entry:

CALIB	
TEMP. -COMP. SOURCE	
MAN. TEMPERATURE	

- * With manual temperature entry, use the  and  keys to set the calibration solution temperature and confirm your entry with the  key.

E1	CALIB
INPUT	+025.0 °C
TEMP.	

- * Wait until the display value has stabilized; then press  to continue.

CALIB	
MEASUREM.	6.02
REFERENCE	pH
	25.0 °C

- * Set the displayed value to the buffer solution value with the  or  keys;

8 Calibrating a pH measurement chain

then press **PGM** to continue.

E1 CALIB	
INPUT	+06.10
REFERENCE	pH

* Use the **PGM** key to accept the zero point or the **EXIT** key to reject it.

CALIB	
ZERO POINT	7.10pH

The instrument returns to measuring mode.

MEASURING	7.37
25.0°C	pH

8.4 2-point calibration



The buffer solutions (reference solutions) used for calibration must differ by at least 2 pH!

During the calibration, the temperature of the two buffer solutions must be identical and remain constant!

- * Make preparations, see section 8.2 "General information", page 46 .
- * Start calibration, see section 8.2.2 "Ways to start the calibration", page 47.
- * Select 2-point calibration.

ZERO POINT	>
2-POINT	>
3-POINT	>

- * Immerse the combination electrode in the first buffer solution with the known pH value.
- * Start the two-point calibration with the **PGM** key.

8 Calibrating a pH measurement chain



Now the source of temperature acquisition can be selected (manually, or using the temperature input of the basic board, or the temperature input via the optional board). This source will be active for the duration of the calibration.

An example follows: Manual temperature entry:

CALIB	
TEMP. -COMP. SOURCE	
MAN. TEMPERATURE	

- * With manual temperature entry, use the and keys to set the calibration solution temperature and confirm your entry with the key.

E1	CALIB
INPUT	+025.0 °C
TEMP.	

- * Wait until the display value has stabilized; then press to continue.

CALIB	
MEASUREMENT.	7.06
REF. 1	pH
	25.0 °C

- * Set the displayed value to the value of the first buffer solution with the and keys; then press to continue.

CALIB	
INPUT	+07.03
REF. 1	pH

- * Rinse and dry the pH combination electrode.
- * Immerse the pH combination electrode in the second buffer solution.
- * Wait until the display value has stabilized; then press to continue.

CALIB	
MEASUREMENT.	4.03
REF. 2	pH
	25.0 °C

- * Set the displayed value to the second buffer solution value with the or

8 Calibrating a pH measurement chain

 keys; then press  to continue.

```
CALIB
-----
INPUT          +04.01
REF.  2        PH
```

The zero point and slope determined by the instrument are displayed.

- * Use the  key to accept the calibrated values or reject them with the  key.

```
CALIB
-----
ZERO POINT    7.03pH
SLOPE         99.4%
```

The instrument returns to measuring mode.

```
MEASURING     7.37
              PH
25.0°C
```

8.5 3-point calibration



The buffer solutions (reference solutions) used for calibration must have the following values:

Buffer solution 1: in the neutral range (if possible precisely 7 pH)

Buffer solution 2: Greater than 9 pH

Buffer solution 3: Less than 5 pH

The temperature of the buffer solutions must be equal and remain constant during calibration!

The buffer solutions can be used in any order during the calibration.

- * Make preparations, see section 8.2 "General information", page 46 .
- * Start calibration, see section 8.2.2 "Ways to start the calibration", page 47.
- * Select 3-point calibration.

```
ZERO POINT    >
2-POINT       >
3-POINT       >
```

- * Immerse the combination electrode in the first buffer solution with the known pH value.

8 Calibrating a pH measurement chain



- * Start the 3-point calibration with the  key.



Now the source of temperature acquisition can be selected (manually, or using the temperature input of the basic board, or the temperature input via the optional board). This source will be active for the duration of the calibration.

An example follows: Manual temperature entry:



CALIB	
TEMP. -COMP. SOURCE	
MAN. TEMPERATURE	

- * With manual temperature entry, use the  and  keys to set the calibration solution temperature and confirm your entry with the  key.

E1	CALIB
INPUT	+025.0 °C
TEMP.	

- * Wait until the display value has stabilized; then press  to continue.

CALIB	
MEASUREM.	4.01
REF. 1	pH
	25.0 °C

- * Set the displayed value to the value of the first buffer solution with the  and  keys; then press  to continue.

CALIB	
INPUT	+04.02
REF. 1	pH

- * Rinse and dry the combination electrode.
- * Immerse the combination electrode in the second buffer solution with the known pH value. Wait until the display value has stabilized; then press  to continue

CALIB	
MEASUREM.	6.96
REF. 2	pH
	25.0 °C

- * Set the displayed value to the second buffer solution value with the  or

8 Calibrating a pH measurement chain

▲ keys; then press PGM to continue.

CALIB	
INPUT	+07.01
REF. 2	pH

- * Rinse and dry the combination electrode.
- * Immerse the combination electrode in the third buffer solution with the known pH value. Wait until the display value has stabilized; then press PGM to continue.

CALIB	
MEASUREMENT	10.01
REF. 3	pH
	25.0 °C

- * Set the displayed value to the third buffer solution value with the ▼ and ▲ keys; then press PGM to continue.

CALIB	
INPUT	+10.03
REF. 3	pH

The zero point of the combination electrode determined by the instrument and its slope in the acidic and alkaline ranges of the characteristic curve are also displayed.

- * Use the PGM key to accept the calibrated values or reject them with the EXIT key.

CALIB	
ZERO POINT	7.01 pH
SLOPE ACID	100.3 %
SLOPE ALCA	99.4 %

The instrument returns to measuring mode.

MEASURING	7.37
25.0 °C	pH

8 Calibrating a pH measurement chain

8.6 pH Antimony measurement chain

Antimony measurement chains are calibrated similarly to "normal" pH measurement chains.

- General information on calibration See "General information" page 46.
- Zero point calibration see section 8.3 "Zero point (1-point) calibration", page 48.
- 2-point calibration see section 8.4 "2-point calibration", page 49.
- 3-point calibration see section 8.5 "3-point calibration", page 51.

8.7 ISFET pH combination electrodes

ISFET pH combination electrodes are calibrated similarly to "normal" pH measurement chains.

- General information on calibration See "General information" page 46.
- Zero point calibration see section 8.3 "Zero point (1-point) calibration", page 48.
- 2-point calibration see section 8.4 "2-point calibration", page 49.
- 3-point calibration see section 8.5 "3-point calibration", page 51.

9 Calibrating a redox measurement chain

9.1 Notes



During calibration, relays and analog output signals adopt their configured states!



When is calibration required?

- At regular intervals (depending on the sample medium and requirements).
- If negative values appear in the top display.
- If the top display indicates "Underrange / Overrange".

Every successfully completed calibration is documented in the calibration logbook, see section 12 "Calibration logbook", page 79.

9.2 General information

The electrical properties of all sensors vary slightly from instance to instance and also change during operation (due to deposits or wear, etc.). This changes the output signal of the sensor.

9.2.1 Requirements

- The instrument must be supplied with voltage, see section 5 "Installation", page 15 ff.
 - A redox sensor must be connected to the transmitter.
-



For a configuration example see section 7.2.1 "Measuring the pH value with pH combination electrode", page 41.

A redox sensor can be

- connected directly to the main input or
- connected to the "Analog input (universal)" optional board via a 2-wire transmitter.

A temperature compensation is **not** performed during the measurement of the redox potential!

- "REDOX" must be configured as sensor in the basic setting.
- The instrument is in Measurement mode.

9 Calibrating a redox measurement chain

9.2.2 Ways to start the calibration



Select the input to which the pH sensor is connected.



If Calibration level is not released

- Press the  key for longer than 3 seconds / ADMINISTR. LEVEL / PASSWORD / CALIBR. LEVEL / MAIN INPUT or OPTION INPUT.

If Calibration level is released

- Press the  and  keys simultaneously / MAIN INPUT or OPTION INPUT.

If Calibration level is released

- Press the  key for longer than 3 seconds / CALIBR. LEVEL / MAIN INPUT or OPTION INPUT.

9.2.3 Calibration options

The instrument offers two calibrating options for adjusting it to the redox measurement chain.

- One-point calibration
If "mV" was configured as UNIT.
- One-point calibration
If "mV" or "CUST. SPECS." was configured as UNIT.

One-point offset calibration

The zero point of the pH combination electrode is calibrated, see section 8.3 "Zero point (1-point) calibration", page 48.

Recommended only for special applications, such as ultra-pure water.

Two-point calibration

The zero point and slope of the combination electrode are calibrated, see section 8.4 "2-point calibration", page 49.

This is the recommended calibration for most sensors.

9 Calibrating a redox measurement chain

9.3 Zero-point calibration (one-point offset calibration)



Zero point calibration is only available if the unit is configured as "mV"!

- * Make preparations, see section 9.2 "General information", page 55 .
- * Start calibration, see section 9.2.2 "Ways to start the calibration", page 56.
- * Select zero point calibration.

```
ZERO POINT >
```

- * Immerse the combination electrode in a test solution with a known redox potential.
- * Start the zero point calibration with the **PGM** key.

```
CALIB
MEASUREMENT 414
REFERENCE    mV
```

Wait until the display value has stabilized; then press **PGM** to continue.

- * Set the displayed value to the test solution value with the **▼** or **▲** keys; then press **PGM** to continue.

```
CALIB
INPUT        +0432
REFERENCE    mV
```

The zero point determined by the instrument is displayed.

```
CALIB
ZERO POINT  17.8mV
```

- * Use the **PGM** key to accept the value or the **EXIT** key to reject it.

9 Calibrating a redox measurement chain

The instrument returns to measuring mode.

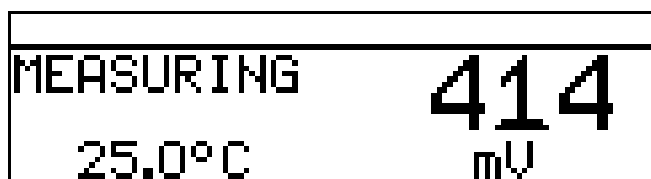

Calibration is complete

After rinsing, the combination electrode can again be used to take measurements.

9.4 2-point calibration



This procedure can be used to scale the absolute input signal (mV) to a displayed relative value (%). That greatly simplifies the evaluation of the measured value (good / bad).

Two-point calibration is only available if the unit is configured as "%" or "Cust. specs."!

- * Make preparations, see section 9.2 "General information", page 55 .
- * Start calibration, see section 9.2.2 "Ways to start the calibration", page 56.
- * Select 2-point calibration.



- * Immerse the combination electrode in a solution with a known "good" redox potential.
- * Start the 2-point calibration with the **PGM** key. Wait until the display value has stabilized; then press **PGM** to continue.



- * Set the displayed value to the relative "good" value (in this example 20%) with the **▼** and **▲** keys; then press **PGM** to continue.

9 Calibrating a redox measurement chain

CALIB	
INPUT	+020.0
REF. 1	%

- * Rinse and dry the redox combination electrode.
- * Immerse the combination electrode in a solution with a known "bad" redox potential. Wait until the display value has stabilized; then press to continue.

CALIB	
MEASUREM.	352
REF. 2	mV

- * Set the displayed value to the relative "bad" value (in this example 80%) with the and keys; then press to continue.

CALIB	
INPUT	+080.0
REF. 2	%

- * The zero point and slope determined by the instrument are displayed.

CALIB	
ZERO POINT	-39 %
SLOPE	493 %

- * Use the key to accept the calibrated values or reject them with the key.

MEASURING	80
25.0°C	%

The instrument returns to measuring mode.

Calibration is complete

After rinsing, the combination electrode can again be used to take measurements.

10 Calibrating an ammonia measuring cell

10.1 Notes



During calibration, relays and analog output signals adopt their configured states!



When is calibration required?

- At regular intervals (depending on the sample medium and requirements).
- If negative values appear in the top display.
- If the top display indicates "Underrange / Overrange".

Every successfully completed calibration is documented in the calibration logbook, see section 12 "Calibration logbook", page 79.

10.2 General information

The electrical properties of all sensors vary slightly from instance to instance and also change during operation (due to deposits or wear, etc.). This changes the output signal of the sensor.

The transmitter uses a typical, concentration-dependent characteristic to measure ammonia with "normal" accuracy requirements. The individual properties of the sensor are taken into account here by offsetting the zero point. This considerably reduces the effort required for calibration.

The transmitter software is specially adapted for coolant monitoring.

10.2.1 Requirements

- The instrument must be supplied with voltage, see section 5 "Installation", page 15 ff.
 - An ammonia sensor must be connected to the transmitter.
-



For a configuration example see section 7.2.1 "Measuring the pH value with pH combination electrode", page 41.

An ammonia sensor can be

- connected directly to the main input or
 - connected to the "Analog input (universal)" optional board via a 2-wire transmitter.
-

- "AMMONIA" must be configured as sensor in the basic setting.

10 Calibrating an ammonia measuring cell

10.2.2 Ways to start the calibration

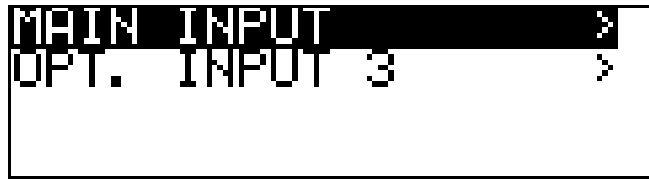

Select the input to which the sensor is connected.



If Calibration level is not released

- Press the  key for longer than 3 seconds / ADMINISTR. LEVEL / PASSWORD / CALIBR. LEVEL / OPTIONAL INPUT.

If Calibration level is released

- Press the  and  keys simultaneously / OPTION INPUT.

If Calibration level is released

- Press the  key for longer than 3 seconds / CALIBR. LEVEL / OPTION INPUT.

10.3 Zero point (1-point) calibration

- The transmitter is in "Measuring mode".

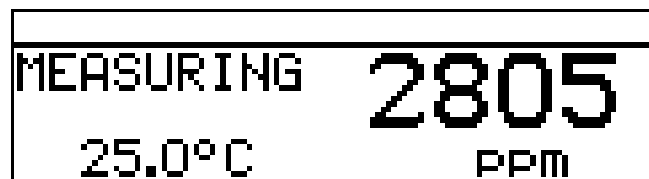

- * Immerse the combination electrode in a solution **without ammonia**.
- * Make preparations, See "Requirements" page 60 .
- * Start calibration, See "Ways to start the calibration" page 61.



- * Start the zero point calibration with the  key.



Now the source of temperature acquisition can be selected (manually, or using the temperature input of the basic board, or the temperature input via the optional board). This source will be active for the duration of the calibration.

An example follows: Manual temperature entry:

10 Calibrating an ammonia measuring cell

CALIB	
TEMP. -COMP. SOURCE	
MAN. TEMPERATURE	

- * With manual temperature entry, use the \blacktriangledown and \blacktriangle keys to set the solution temperature and confirm your entry with the $\boxed{\text{PGM}}$ key.

E1	CALIB
INPUT	+025.0 °C
TEMP.	

- * Wait until the display value has stabilized; then press $\boxed{\text{PGM}}$ to continue

CALIB	
MEASUREMENT	-0.1
REFERENCE	mV
	25.0 °C

- * Wait until the display value has stabilized; then press $\boxed{\text{PGM}}$ to continue.

CALIB	
ZERO POINT	-0.1mV

- * Use the $\boxed{\text{PGM}}$ key to accept the calibration result or the $\boxed{\text{EXIT}}$ key to reject it.

MEASURING	0
25.0 °C	PPM

The instrument returns to measuring mode.

Calibration is complete

After rinsing, the sensor can again be used to take measurements.

11 Calibrating a sensor with a standard signal

11.1 General information



During calibration, relays and analog output signals adopt their configured states!



Sensors with a standard signal output can only be connected to an "Analog input (universal)" optional board!

The sensors connected to the instrument should be cleaned and the instrument itself calibrated, at regular intervals (subject to the sample medium).

Every successfully completed calibration is documented in the calibration logbook, See section 12 "Calibration logbook", page 79.

11.1.1 Operating modes

The operating mode selection depends on which sensor (transmitter) is connected.

Linear operating mode

For example sensor for free chlorine, redox, pressure, liquid level or humidity

pH operating mode

For example pH sensor

Conductivity operating mode

For example sensor for conductivity, concentration

Customer specs.

For sensors with non-linear characteristics.

Up to xx interpolation points can be defined in an instrument table.

This allows for an excellent approximation of a non-linear characteristic.

Chlorine, pH and temperature-compensated

Combination of chlorine sensor and pH sensor and temperature sensor.

The measured value for chlorine often depends to a great extent on the pH value of the solution.

The chlorine measurement is compensated depending on the pH value in this operating mode. The pH measurement is temperature-compensated

11 Calibrating a sensor with a standard signal

11.1.2 Calibration options

Different calibration options are available depending on the operating mode.

Operating mode	Calibration options					Page
	1-point	2-point	Limit point	Rel. cell const.	Temp. coeffic.	
Linear	X	X	X	-	-	65
pH	X	X	-	-	-	69
Conductivity	-	-	-	X	X	70
Concentration	-	-	-	X		76
Customer specs.	Due to the table with interpolation points, no calibration is required					
Chlorine, pH-compensated	-	-	X	-	-	77

- With **one-point (offset) calibration**, the zero point of the sensor is calibrated.
- With **two-point calibration**, the zero point and slope of the sensor are calibrated. This is the recommended calibration for most sensors.
- With **one-point final value calibration**, the slope of the sensor is calibrated. This is the recommended calibration for chlorine sensors, for example.
- **Calibration of relative cell constant**
With conductivity measuring cells only.
- **Calibration of the temperature coefficient**
With conductivity measuring cells only.

11.1.3 Ways to start the calibration

Select the input to which the sensor is connected.



If Calibration level is not released

- Press the key for longer than 3 seconds / ADMINISTR. LEVEL / PASSWORD / CALIBR. LEVEL / OPTIONAL INPUT.

If Calibration level is released

- Press the and keys simultaneously / OPTION INPUT.

If Calibration level is released

- Press the key for longer than 3 seconds / CALIBR. LEVEL / OPTION INPUT.

11 Calibrating a sensor with a standard signal

11.2 Linear operating mode

11.2.1 1-point calibration



This example is based on a liquid level measurement (as a %).
The input signal is provided by a pressure transmitter.

- The transmitter is in "Measuring mode".

```
MAIN VAL. 7.00 pH
TEMP. INP. 25.0 °C
OPT. IN 3 2.5 %
```

- * Now bring the system to a defined state (e.g. when measuring liquid level, empty the container).
- * Start the calibration, See "Ways to start the calibration" page 64.
- * Select the zero point calibration with the **PGM** key.

```
ZERO POINT >
LIMIT POINT >
2-POINT >
```

- * Wait until the display value has stabilized; then press **PGM** to continue.

```
          CALIB
MEASUREM.      2.5
REFERENCE      %
```

Set the displayed value to the required value (usually 0%) with the **▼** and **▲** keys; then press **PGM** to continue.

```
          CALIB
INPUT          +000.0
REFERENCE      %
```

The zero point determined by the instrument is displayed.

11 Calibrating a sensor with a standard signal

CALIB	
ZERO POINT	-2.5%

Use the **PGM** key to accept the value or the **EXIT** key to reject it.
The instrument returns to measuring mode.

MAIN VAL.	7.00 pH
TEMP. INP.	25.0 °C
OPT. IN 3	0.0 %

Calibration is complete

After rinsing, the sensor can again be used to take measurements.

11.2.2 Two-point calibration



The values determined during calibration (zero point and slope) work out as follows:

$$\text{Display} = \frac{\text{Input value}}{\text{Slope}} + \text{Zero point}$$

This example is based on a liquid level measurement. The input signal is provided by a pressure transmitter.

- The transmitter is in "Measuring mode".

MAIN VAL.	7.00 pH
TEMP. INP.	25.0 °C
OPT. IN 3	2.5 %



- * Now bring the system to a defined state (e.g. when measuring liquid level, empty the container).
- * Start the calibration, See "Ways to start the calibration" page 64.
- * Select the 2-point calibration with the **PGM** key.

11 Calibrating a sensor with a standard signal

```
ZERO POINT >
LIMIT POINT >
2-POINT >
```

- * Wait until the display value has stabilized; then press  to continue.



```
          CALIB
-----
MEASUREM.      2.5
REF. 1          %
```

- * Set the displayed value to the required value (usually 0) with the  and  keys; then press  to continue.

```
          CALIB
-----
INPUT          +000.0
REF. 1          %
```

- * Now bring the system to a second defined state (e.g. when measuring liquid level, container full).
Wait until the display value has stabilized; then press  to continue

```
          CALIB
-----
MEASUREM.      94.9
REF. 2          %
```

- * Set the displayed value to "Maximum" (usually 100%) with the  and  keys; then press  to continue.

```
          CALIB
-----
INPUT          +100.0
REF. 2          %
```

The zero point and slope determined by the instrument are displayed.

```
          CALIB
-----
ZERO POINT    -2.7%
SLOPE         108.2%
```

11 Calibrating a sensor with a standard signal

- * Use the **PGM** key to accept the calibrated values or reject them with the **EXIT** key.
- * The instrument returns to measuring mode.

```
MAIN VAL. 7.00 pH
TEMP. INP. 25.0 °C
OPT. IN 3 100.0 %
```

Calibration is complete

After rinsing, the sensor can again be used to take measurements.

11.2.3 Calibration end point



This example is based on a measurement of free chlorine. The input signal is provided by a corresponding transmitter.

- The transmitter is in "Measuring mode".

```
MAIN VAL. 7.00 pH
TEMP. INP. 25.0 °C
OPT. IN 3 1.59 PPM
```

- * The process must now be brought to the state that is as relevant as possible to the final value (e.g. when measuring chlorine, the required concentration).
- * Start the calibration, See "Ways to start the calibration" page 64.
- * Select the limit point calibration with the **PGM** key.

```
ZERO POINT >
LIMIT POINT >
2-POINT >
```

- * Wait until the display value has stabilized; then press **PGM** to continue.

```
CALIB
MEASUREMENT 1.94
REFERENCE PPM
```

Set the displayed value to the measured reference value with the **▼** or **▲** keys; then press **PGM** to continue.

11 Calibrating a sensor with a standard signal

CALIB	
INPUT	+02.00
REFERENCE	PPM

The slope determined by the instrument is displayed.

* Use the **PGM** key to accept the value or the **EXT** key to reject it.

CALIB	
SLOPE	97.5%

* The instrument returns to measuring mode.

MAIN VAL.	7.00 pH
TEMP. INP.	25.0 °C
OPT. IN 3	2.00 PPM

Calibration is complete

After rinsing, the sensor can again be used to take measurements.

11.3 pH operating mode

11.3.1 Zero point (1-point) calibration



This example is based on a glass combination electrode with a connected two-wire transmitter.

- The transmitter is in "Measuring mode".

MAIN VAL.	7.00 pH
TEMP. INP.	25.0 °C
OPT. IN 3	6.12 pH

* Perform calibration, See section 8.3 "Zero point (1-point) calibration", page 48.

11 Calibrating a sensor with a standard signal

11.3.2 2-point calibration



This example is based on a glass combination electrode with a connected two-wire transmitter.

- The transmitter is in "Measuring mode".

MAIN VAL.	7.00 pH
TEMP. INP.	25.0 °C
OPT. IN 3	6.12 pH

- * Perform calibration, See section 8.4 "2-point calibration", page 49.

11.4 Conductivity operating mode

11.4.1 Calibration of the relative cell constant



This example is based on a conductivity cell with a connected two-wire transmitter.

- The transmitter is in "Measuring mode".

MAIN VAL.	7.00 pH
TEMP. INP.	25.0 °C
OPT. IN 3	109 µS/cm

- * Immerse the conductivity sensor in a reference solution with a known conductivity.
- * Start the calibration, See "Ways to start the calibration" page 64.
- * Select REL. CELL CONST.
- * Press the  key.

TEMP. COEFF. LIN.	>
REL. CELL CONST.	>

- * When the measured value is stable, press the  key

11 Calibrating a sensor with a standard signal

CALIB	
MEASUREMENT	1950
REFERENCE	$\mu\text{S}/\text{cm}$

- * The measured conductivity value flashes on the display.

CALIB	
INPUT	+02000
REFERENCE	$\mu\text{S}/\text{cm}$

- * Use the \blacktriangledown or \blacktriangle keys to set the value to the actual conductivity.
- * Press the $\boxed{\text{PGM}}$ key;
the relative cell constant determined by the instrument is displayed (as a %).

CALIB	
CELL CONST	102.6 %

- * Use the $\boxed{\text{PGM}}$ key to accept the temperature coefficient or the $\boxed{\text{EXIT}}$ key to reject it.

MAIN VAL.	7.00 pH
TEMP. INP.	25.0 °C
OPT. IN 3	2000 $\mu\text{S}/\text{cm}$

The current measurement value and the temperature are displayed.

Calibration is complete

After rinsing, the sensor can again be used to take measurements.

11 Calibrating a sensor with a standard signal

11.4.2 Calibration of the temperature coefficient

Linear temperature coefficient



This example is based on a conductivity cell with a connected two-wire transmitter.

- The transmitter is in "Measuring mode".

MAIN VAL.	7.00 pH
TEMP. INP.	25.0 °C
OPT. IN 3	109 µS/cm

* Immerse the conductivity sensor in the sample medium.

Start the calibration, See "Ways to start the calibration" page 64.

* Select "LINEAR TEMP. COEF".

TEMP. COEFF. LIN.	>
REL. CELL CONST.	>

The current sensor temperature flashes in the display (1).

CALIB	
INPUT	024.4 °C (1)
WORK-TEMP.	
< 20.0 °C	> 30.0 °C



The working temperature must be at least 5°C above or below the reference temperature (25.0°C).

* Enter the required working temperature and confirm your entry.

The LC display now shows the selected working temperature (flashing) (2).

CALIB	
INPUT	+075.0 °C (2)
WORK-TEMP.	
< 20.0 °C	> 30.0 °C

11 Calibrating a sensor with a standard signal

- * Press the **PGM** key.

CALIB		
T1	25.0 °C	416
T2	74.4 °C	μS/cm
		24.5 °C

The conductivity (399 μS/cm) at the current temperature (24.3°C) now appears on the right of the LC display.

The temperatures T1 (25°C) and T2 (70.0°C) that have yet to be triggered are shown on the left.

- * Press the **PGM** key.

- * Heat the sample medium until the working temperature is reached.



During calibration, the rate of temperature change in the measurement solution must not exceed 10°C/min.

Calibration is also possible in the cooling process (with a falling temperature). It starts above the working temperature and ends below the working temperature.

As soon as the temperature of the sample medium exceeds T1 (25°C), this is hidden on the display. The uncompensated conductivity at the current temperature is displayed on the right.

CALIB		
T2	75.0 °C	833
		μS/cm
		74.6 °C

If the temperature of the medium exceeded T2 (73.0°C), the instrument determines the temperature coefficient.

The LC display now shows the determined temperature coefficient as %/K.

CALIB	
TEMP. COEFF	1.99 %/K

- * Use the **PGM** key to accept the temperature coefficient or the **EXIT** key to reject it.

MAIN VAL.	7.00 pH
TEMP. INP.	75.0 °C
OPT. IN 3	417 μS/cm

11 Calibrating a sensor with a standard signal

The transmitter is in "measuring mode" and displays the compensated conductivity of the solution.

Calibration is complete

After rinsing, the sensor can again be used to take measurements.

With non-linear temperature coefficient (TEMP. COEF. CURVE)



This example is based on a conductivity cell with a connected two-wire transmitter.

The non-linear temperature coefficient can **only** be calibrated with a rising temperature!

The start temperature **must be below** the configured reference temperature (usually 25°C)!

The "TEMP.COEF. CURVE" menu item is only displayed if a temperature sensor is connected and "TEMP.COEF. CURVE" is configured as the type of temperature compensation.

- The transmitter is in "Measuring mode".

```
MAIN VAL. 7.00 pH
TEMP. INP. 25.0 °C
OPT. IN 3 109 µS/cm
```

* Immerse the conductivity sensor in the sample medium.

Start the calibration, See "Ways to start the calibration" page 64.

* Select "TEMP. COEF. CURVE" and press the  key.

```
TEMP. COEFF. CURVE >
REL. CELL CONST. >
```

* Enter the required start temperature (1) for the temp. coef. curve.

```
          CALIB
INPUT      +024.0 °C — (1)
START TEMP
```

* Enter the required end temperature (2) for the temp. coef. curve.

```
          CALIB
INPUT      +075.0 °C — (2)
END TEMP
```

11 Calibrating a sensor with a standard signal

- * Heat the sample medium continuously
 - (3) the current uncompensated conductivity
 - (4) the current temperature of the sample medium
 - (5) the first target temperature

CALIB	
NEXT	416
TEMP.	$\mu\text{S}/\text{cm}$
24.0°C	22.3 °C

(3) ———

(4) ———

(5) ———



During calibration, the rate of temperature change in the measurement solution must not exceed 10°C/min.

During the calibration process, the instrument displays values for the following five temperature interpolation points.

CALIB	
NEXT	426
TEMP.	$\mu\text{S}/\text{cm}$
25.0°C	24.0 °C

The end temperature has been reached

Use the key to accept the temperature coefficients or the key to reject the calibration result.

CALIB	
1: 3.91 %/K	2: 3.67 %/K
3: 3.35 %/K	4: 3.12 %/K
5: 2.87 %/K	6: 2.51 %/K

The LC display now shows the determined temperature coefficients as %/K.

- * Use the key to accept the temperature coefficients or the key to reject the values.

MAIN VAL.	7.00 pH
TEMP. INP.	75.0 °C
OPT. IN 3	417 $\mu\text{S}/\text{cm}$

The transmitter is in "measuring mode" and displays the compensated conductivity of the solution.

Calibration is complete

After rinsing, the sensor can again be used to take measurements.

11 Calibrating a sensor with a standard signal

11.5 Concentration operating mode

11.5.1 Calibration of the relative cell constant



This example is based on a conductivity cell with a connected two-wire transmitter.

The conductivity of a caustic solution is converted into a concentration value [%] by the instrument.

- The transmitter is in "Measuring mode".

MAIN VAL.	7.00 pH
TEMP. INP.	24.1 °C
OPT. IN 3	2.1 %

- * Immerse the conductivity sensor in a sample medium with a known conductivity.
- * Start the calibration, See "Ways to start the calibration" page 64.
- * Press the key.

REL. CELL CONST.	>
------------------	---

The measured conductivity value is displayed.

- * Wait until the measurement value has stabilized.
- * Press the key.

CALIB	
MEASUREMENT	104
REFERENCE	mS/cm

- * Use the and keys to set the value to the actual conductivity.

CALIB	
INPUT	+00107
REFERENCE	mS/cm

- * Press the key; the relative cell constant determined by the instrument is displayed (as a %).

CALIB	
CELL CONST	103.3 %

11 Calibrating a sensor with a standard signal

- * Use the **PGM** key to accept the relative cell constant or the **EXIT** key to reject the values.

MAIN VAL.	7.00 pH
TEMP. INP.	24.2 °C
OPT. IN 3	2.1 %

The transmitter is in "measuring mode" and displays the compensated conductivity of the solution.

Calibration is complete

After rinsing, the sensor can again be used to take measurements.

11.6 Chlorine measurement operating mode, pH-compensated

11.6.1 Final value calibration



The pH signal and temperature signal are supplied via the main input, the chlorine signal (standard signal) via the optional input.

- The transmitter is in "Measuring mode".

MAIN VAL.	7.00 pH
TEMP. INP.	24.2 °C
OPT. IN 3	1.04 PPM

Calibrate pH sensor

- * Perform calibration, See section 8 "Calibrating a pH measurement chain", page 46.

Calibrate chlorine sensor



- * The process must now be brought to the state that is as relevant as possible to the final value (e.g. when measuring chlorine, the required concentration).
- * Start the calibration, See "Ways to start the calibration" page 64.
- * Select the limit point calibration with the **PGM** key.

11 Calibrating a sensor with a standard signal





* Wait until the display value has stabilized; then press  to continue.



Set the displayed value to the measured reference value with the  or  keys; then press  to continue.



The slope determined by the instrument is displayed.

* Use the  key to accept the value or the  key to reject it.

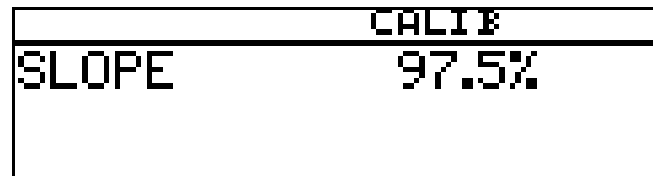

The instrument returns to measuring mode.

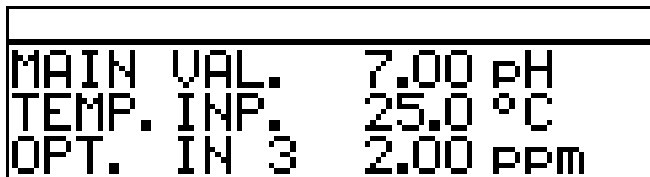

Calibration is complete

After rinsing, the sensor can again be used to take measurements.

12.1 General information

The characteristic data for the last 5 successful calibration processed are documented in the calibration logbook.

Calling up

The instrument is in Measurement mode.

* Press the  key for longer than 3 seconds.

```
USER LEVEL >
ADMINISTR. -LEVEL >
CALIBR. -LEVEL >
CALIBR. -LOGBOOK >
```

Select input

Briefly press the  key.

```
MAIN INPUT >
OPT. INPUT 1 >
OPT. INPUT 2 >
OPT. INPUT 3 >
```

Most recent successful calibration



The "time stamp" in the following screen printouts (top left, for example 11-06-06 12:02) only appear if optional slot 3 is fitted with the "Datalogger with interface RS485"!

* Briefly press the  key.

```
00000 HRS.
ZERO POINT 6.95 pH
SLOPE ACID 100.7 %
SLOPE ALCA 101.7 %
```

Next most recent successful calibration

* Briefly press the  key.

```
00000 HRS.
ZERO POINT 7.05 pH
SLOPE 98.4 %
```

12 Calibration logbook

Next most recent successful calibration

* Briefly press the  key.

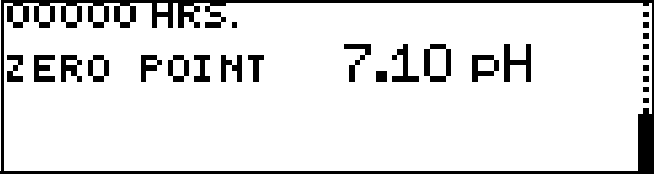

00000 HRS.
ZERO POINT 7.10 PH

13.1 General information



Apart from faulty installation, incorrect settings on the instrument may also affect the proper functioning of the subsequent process or lead to damage. You should therefore always provide safety equipment that is independent of the instrument and it should only be possible for qualified personnel to make settings.

13.2 Controller functions



"Software" control functions are assigned to "Hardware" outputs for this instrument.

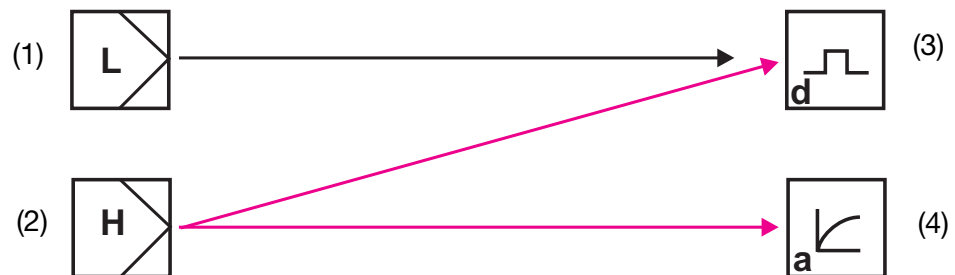

- 1 Software controller for "simple" switching functions (e.g. alarm control)
- 2 Software controller for "higher order" switching functions (e.g. PID controller)
- 3 "Switching" hardware output (e.g. relay)
- 3 "Continuous" hardware output (analog output)

13.2.1 Simple switching functions

Up to four switching functions can be set (limit value 1, 2, 3, 4)
ADMINISTR. LEVEL / PARAMETER LEVEL / LIMIT VALUE CONTR. / LIMIT VALUE x.





13.2.2 Higher order switching functions (PID)

Higher order switching functions are configured at the parameter level via the parameters of "Controller 1 or 2".

ADMINISTR. LEVEL / PARAMETER LEVEL / CONTROLLER / CONTROLLER 1(2) / CONFIGURATION / CONTROLLER TYPE / e.g. PULSE LENGTHS

13 Controller

13.2.3 Typical operator level parameters

Binary outputs	Explanation
Signal source	
No signal	No switching function desired
Limit control 1 to 4	"Simple" switching functions
Alarm function (AF1)	
Alarm function (AF2)	
Alarm function (AF7)	
Alarm function (AF8)	
Controller 1(2)	"Higher order" switching functions
Limit value Pulse width Pulse frequency Steady Modulating	

13.3 Software controllers and outputs

Simple controller functions

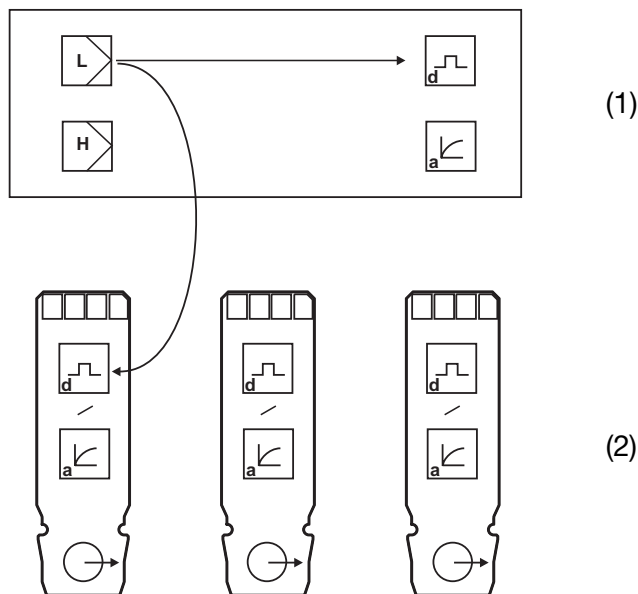

- 1 Main board
- 2 Optional board
- L Simple controller
- H Higher order controller
- d Digital output
- a Analog output



If "Simple controller functions" have been configured, only the digital outputs can be controlled!

The operator must configure which of the digital outputs will be controlled - the main board or optional board 1, 2 or 3

Higher order controller functions

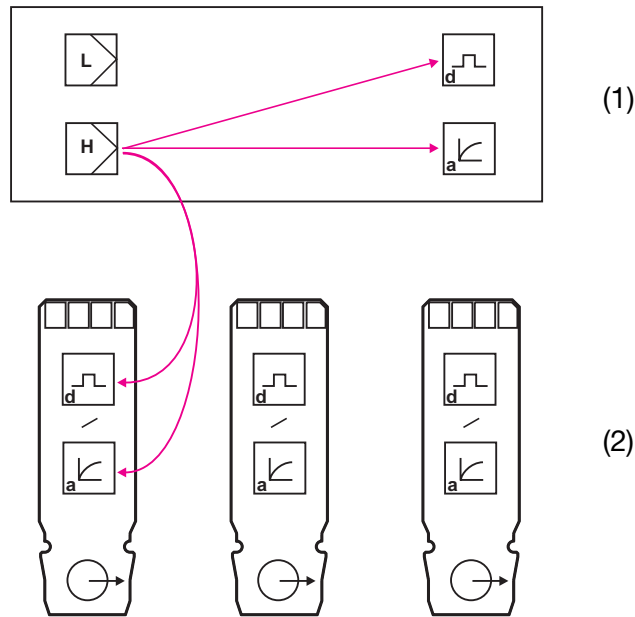

- 1 Main board
- 2 Optional board
- L Simple controller
- H Higher order controller
- d Digital output
- a Analog output



If "higher order controller functions" have been configured, both the digital outputs and the analog outputs can be controlled.

The operator must configure which of the outputs will be controlled - the main board or optional board 1, 2 or 3.



Additional explanations, See section 18.1 "Glossary", page 102.

13 Controller

13.4 Configuration of higher order controllers

13.4.1 Structure

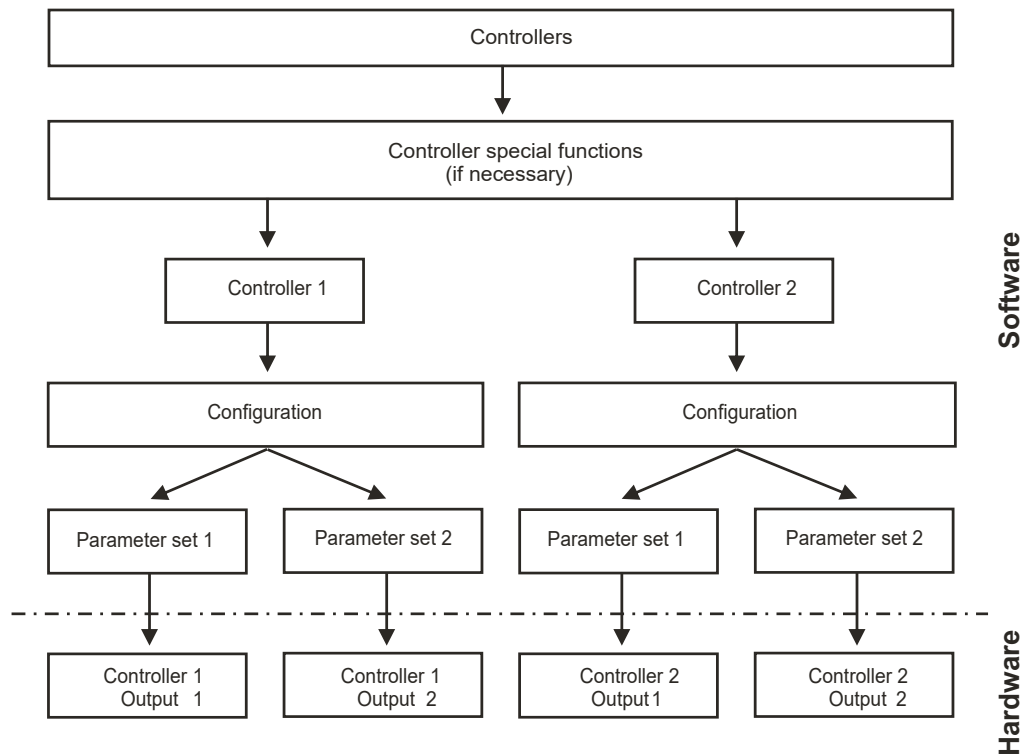

13.5 Parameter sets



Different process steps may require different controller settings. The instrument offers the option of creating two parameter sets and then switching between them by means of a binary input.

Defining a parameter set

ADMINISTR. LEVEL / PARAMETER LEVEL / CONTROLLER / 1(2) / PARAMETER SET 1(2)
See "Controllers" page 115.

Configuring parameter set switchover

ADMINISTR. LEVEL / PARAMETER LEVEL / BINARY INPUTS / BINARY INPUT 1(2) / PARAMET. SWITCHOVER
See "Binary inputs" page 114.

13.6 Sample configurations

13.6.1 Simple limit monitoring

Configuration

Limit monitoring

Limit value 1

Signal source:	Main value
Switching function:	Alarm function  (AF8)
Switching point :	6.50 pH
Hysteresis:	0.50 pH

Limit value 2

Signal source:	Main value
Switching function:	Alarm function  (AF7)
Switching point :	8.50 pH
Hysteresis:	0.50 pH

Configuration of binary output, e.g. relay)

Binary outputs

Binary output 1

Signal source:	Limit monitoring 1
At calibration:	Standard operation
Error:	Inactive
HOLD mode:	Frozen
Turn-on delay:	0 seconds
Turn-off delay:	0 seconds
Wiper time:	0 seconds
Manual mode:	No simulation

Binary output 2

Signal source:	Limit monitoring 2
At calibration:	Standard operation
Error:	Inactive
HOLD mode:	Frozen
Turn-on delay:	0 seconds
Turn-off delay:	0 seconds
Wiper time:	0 seconds
Manual mode:	No simulation

13 Controller

13.6.2 Controller with PID behavior and pulse length output

Configuration of software controllers

Controller 1

Configuration

Controller type:	Pulse lengths
Controller actual value:	Main value
Stroke retransmission:	No signal
Additive disturbance:	No signal
Multiplicative disturbance:	No signal
Min./max. contact:	Min. contact
Inactive/active contact:	Active contact
HOLD mode	0 %
HOLD output:	0 %
Error:	0 %
Alarm control:	Off

Parameter set 1

Min. setpoint:	As required
Max. setpoint:	As required
Setpoint:	6.50 pH
Proportional range:	As required
Reset time:	As required
Rate time:	As required
Period time:	As required
Output limit:	As required
Min. turn-on time:	As required
Alarm tolerance:	As required
Alarm delay:	As required

Controller 2

Configuration

Controller type:	Pulse lengths
Controller actual value ¹ :	Main value
Stroke retransmission ¹ :	No signal
Additive disturbance ¹ :	No signal
Multiplicative disturbance ¹ :	No signal
Min./max. contact:	Max. contact
Inactive/active contact:	Active contact

¹ This parameter only appears if "Separate controllers" has been configured in special controller functions.

HOLD mode	0 %
HOLD output:	0 %
Error:	0 %
Alarm control:	Off

Parameter set 1

Min. setpoint:	As required
Max. setpoint:	As required
Setpoint:	8.50 pH
Proportional range:	As required
Reset time:	As required
Rate time:	As required
Period time:	As required
Output limit:	As required
Min. turn-on time:	As required
Alarm tolerance:	As required
Alarm delay:	As required

Configuration of binary output, e.g. relay)

Binary outputs

Binary output 1

Signal source: Controller 1 output 1

Binary output 2

Signal source: Controller 2 output 1

14 Setup program

14.1 Configurable parameters

Both the setup program (ACM-Soft) and the PC interface cable with USB/TTL converter (ACM-Int) are available as options and provide a convenient way to adapt the transmitter to meet requirements:

- Setting the measuring range.
- Setting the behavior of outputs when the measuring range is exceeded.
- Setting the functions of switching outputs K1 to K8.
- Setting the functions of the binary inputs.
- Setting a customized characteristic
- etc.



Data can only be transferred from or to the transmitter if it is supplied with voltage, See section 5 "Installation", page 15ff.

Connection

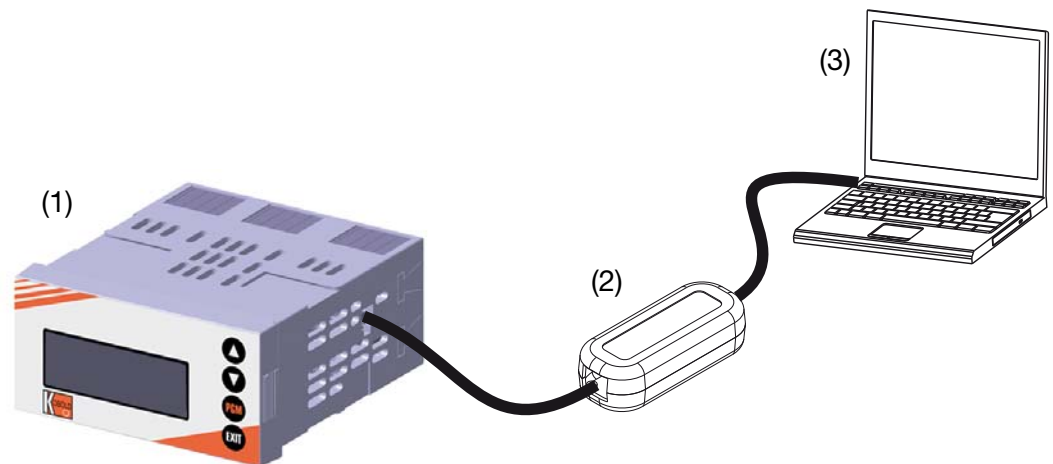

- (1) APM-1
- (2) PC interface cable with USB/TTL converter,
Sales no.: ACM-Int
- (3) PC or notebook

14.2 Documenting the instrument configuration

- * Start the setup program
- * Establish the connection to the instrument (1).

Read the instrument configuration (2).

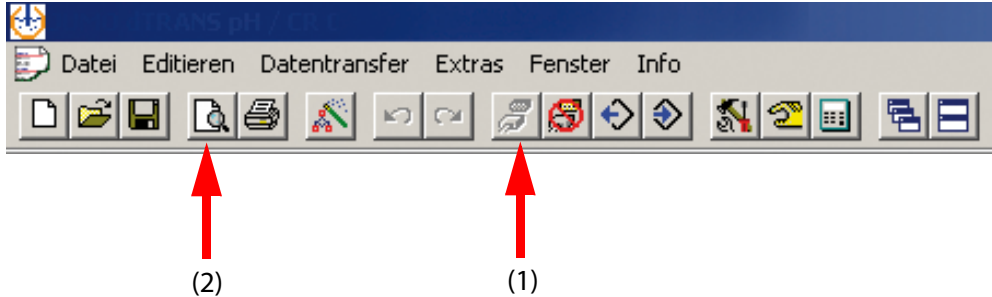

Datei-Info-Kopf:			
Gerätename:	dTRANS02	Erstellungsdatum:	07.06.2011
Geräte-S/W-Version:	269.01.xx	Änderungsdatum:	07.06.2011
VDN:		Programm-Version:	1.00 J
Kurztitel: Bearbeiter: Typenschlüssel: Auftrag: Zusatzinfo:			
Hardware / Grundeinstellung:			
Hardwaretyp: pH / Redox Regler			
Variante: Standard			
Grundeinstellung			
Sensor:	pH Standard Elektrode		
Einheit:	pH		
Optionale Bestückung:			
Optionssteckplatz 1:	Analog-Ausgang		
Optionssteckplatz 2:	Analog-Eingang		
Optionssteckplatz 3:	Datenlogger		
Analogeingang Hauptwert:			
pH / Redox			
Kompensationsquelle:	Temperatur-Eingang		
Überwachung Bezugselektroden:	Aus		
Überwachung Glaselektrode:	Aus		
Filterzeit:	2.0s		
Kalibrierintervall:	0 Tage		
Differenzmessung:	Aus		
Netzfrequenz:	50 Hz		
Analogeingang Temperatur:			
Sensortyp:	Kein Sensor		
Filterzeit:	2.0s		
Manuelle Temperaturvorgabe:	25.0 °C		
Offset:	0.0 °C		
Analogeingang Optionskarten:			
Analogeingang 2			
Betriebsart:	Linear		
Kom ma:	XX,xx		
Einheit:	µS / cm		
Skalierung Anfang:	0.00 µS / cm		
Skalierung Ende:	99.99 µS / cm		
Signalart:	0 ...20 mA		
Filterzeit:	2.0s		
Bearbeiter:		Dokument:	
Gerätename:	dTRANS02	Erstellungsdatum:	Setup1 - geändert -
Geräte-S/W-Version:	269.01.xx	Änderungsdatum:	07.06.2011
Programm-S/W-Version:	1.00 J	Seitenanzahl:	12

14 Setup program

14.3 Special features for "Datalogger"

- * Start the setup program
- * Establish the connection to the instrument (1).
- * Read the instrument configuration (2).

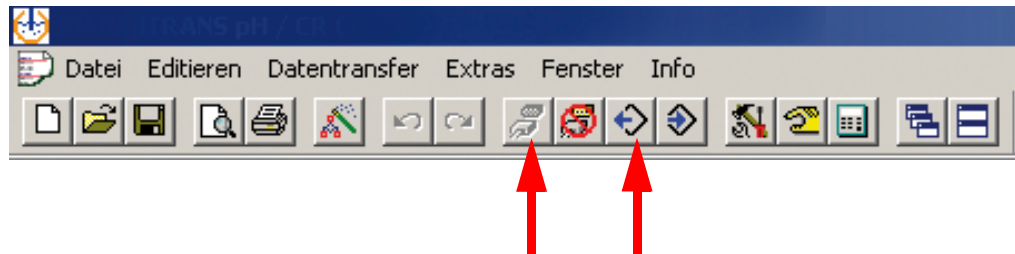

- * Read data from datalogger (for example table view)
 - Mark datalogger icon (3)
 - Read values from the instrument (4)

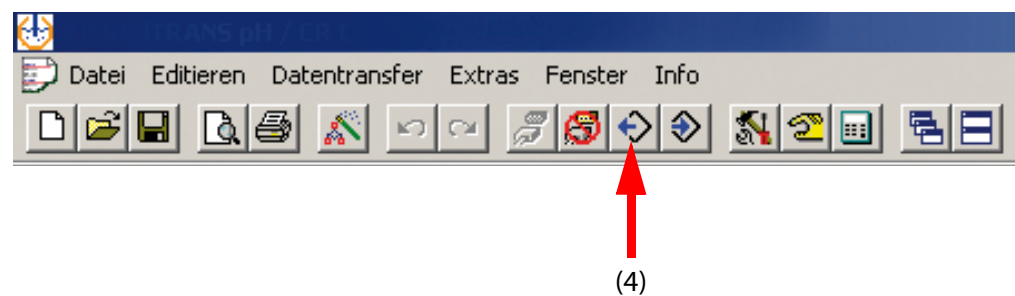
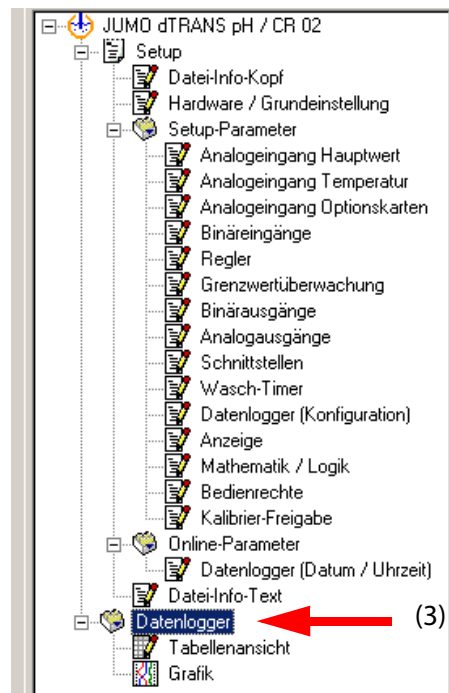

14 Setup program

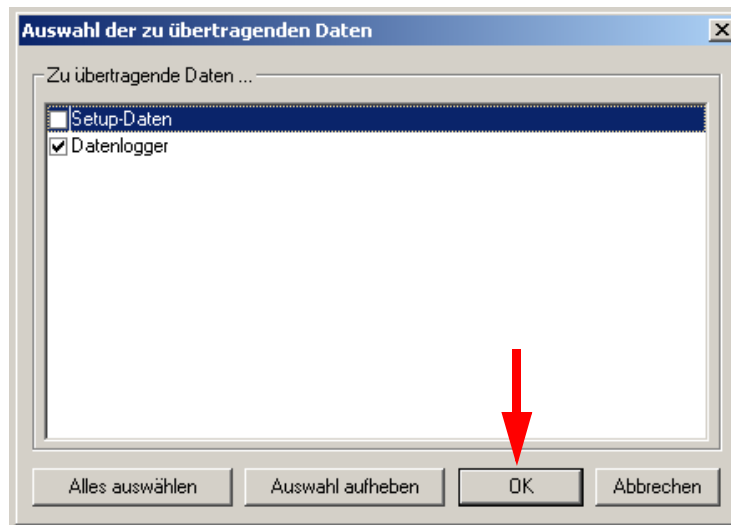

* Export data (for processing in an external program).

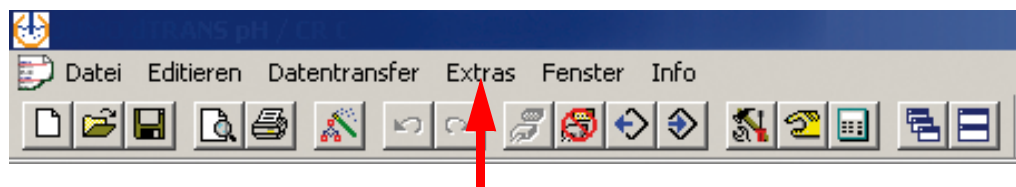

Geräteerkennung: yyyyyyyyyyyyyyyyyy

	Datum	Zeit	Analogwert 1	Einheit 1	Analogwert 2	Einheit 2	Analogwert 3	Einheit 3	Analogwert 4	Einheit 4	Binärausgang 1	Binärausgang 2	Binärausgang 3	Binärausgang 4
1	07.06.2011	14:32:01	7.021104	pH	25	°C	0	%	0	%	0	0	0	0
2	07.06.2011	14:31:01	7.020878	pH	25	°C	0	%	0	%	0	0	0	0
3	07.06.2011	14:30:01	7.021447	pH	25	°C	0	%	0	%	0	0	0	0
4	07.06.2011	14:29:01	7.020861	pH	25	°C	0	%	0	%	0	0	0	0
5	07.06.2011	14:28:01	7.020949	pH	25	°C	0	%	0	%	0	0	0	0
6	07.06.2011	14:27:01	7.020753	pH	25	°C	0	%	0	%	0	0	0	0
7	07.06.2011	14:26:01	7.020559	pH	25	°C	0	%	0	%	0	0	0	0
8	07.06.2011	14:25:01	7.020248	pH	25	°C	0	%	0	%	0	0	0	0
9	07.06.2011	14:24:01	7.020679	pH	25	°C	0	%	0	%	0	0	0	0
10	07.06.2011	14:23:01	7.020659	pH	25	°C	0	%	0	%	0	0	0	0
11	07.06.2011	14:22:01	7.020184	pH	25	°C	0	%	0	%	0	0	0	0
12	07.06.2011	14:21:01	7.020											
13	07.06.2011	14:20:01	7.020											
14	07.06.2011	14:19:01	7.020											
15	07.06.2011	14:18:01	7.020											
16	07.06.2011	14:17:01	7.019											
17	07.06.2011	14:16:01	7.020											
18	07.06.2011	14:15:01	7.020											
19	07.06.2011	14:14:01	7.020											
20	07.06.2011	14:13:01	7.020											
21	07.06.2011	14:12:01	7.019											
22	07.06.2011	14:11:01	7.019											
23	07.06.2011	14:10:01	7.019											
24	07.06.2011	14:09:01	7.021											
25	07.06.2011	14:08:01	7.020	pH	25	°C	0	%	0	%	0	0	0	0
26	07.06.2011	14:07:01	7.020673	pH	25	°C	0	%	0	%	0	0	0	0

Datenlogger Speichern

Bitte Geben Sie ein Trennzeichen ein:

Tabulator

Benutzerdefiniert

Semikolon

Tabulator

Speichern unter Schliessen

15 Eliminating errors and faults

Problem	Possible cause	Action			
No measurement display or current output	There is no supply voltage	Check the power supply			
Measurement display 0000 or current output 4 mA	Sensor not immersed in medium; level in container too low	Top up the container			
	Flow-through fitting is blocked	Clean the flow-through fitting			
	Sensor faulty	Replace the sensor			
Incorrect or fluctuating measurement display	Sensor faulty	Replace the sensor			
	Sensor positioning incorrect	Choose another installation location			
	Air bubbles	Optimize assembly			
HAUPTWERTEINGANG: OVERRANGE	Measurement overrange	Choose a suitable measuring range			
HAUPTWERTEINGANG: UNDERRANGE	Measurement underrange				
<table border="1" style="width: 100%; border-collapse: collapse;"> <tr> <td style="text-align: center;">ALARM</td> </tr> <tr> <td>MESSUNG 8888</td> </tr> <tr> <td style="text-align: center;">25.7°C pH</td> </tr> </table>	ALARM		MESSUNG 8888	25.7°C pH	Main input: Measurement range "out of range"
ALARM					
MESSUNG 8888					
25.7°C pH					
HAUPTINGANG: KOMPENSAT. -BEREICH	Compensation range has been left				
TEMPERATUREINGANG: OVERRANGE	Measurement overrange	Choose a suitable measuring range			
TEMPERATUREINGANG: UNDERRANGE	Measurement underrange				
<table border="1" style="width: 100%; border-collapse: collapse;"> <tr> <td style="text-align: center;">ALARM</td> </tr> <tr> <td>MESSUNG 8888</td> </tr> <tr> <td style="text-align: center;">8888 °C pH</td> </tr> </table>	ALARM		MESSUNG 8888	8888 °C pH	Temperature input: Measurement range "out of range"
ALARM					
MESSUNG 8888					
8888 °C pH					
OPTIONSEINGANG 1: KOMPENSAT. -BEREICH	Compensation range has been left				
OPTIONSEINGANG 1: OUT OF RANGE	Temperature input: Measurement range "out of range"	Choose a suitable measuring range			
GLASELEK. -IMPEDANZ ZU HOCH	Coating	Clean (glass) electrode. Replace (glass) electrode.			

15 Eliminating errors and faults

GLASELEK. -IMPEDANZ ZU NIEDRIG	Membrane glass damaged	Replace (glass) electrode.
BEZUGSEL. -IMPEDANZ ZU HOCH	Coating	Clean reference electrode. Replace reference electrode.
ABHÄNGIGE PARAMETER WURDEN ANGEPASST	Configuration change	OK
DATENLOGGER WIRD GELÖSCHT ...	Configuration change	OK
EBENE GESPERRT	Inhibit via binary contact	Check configuration and unlock if necessary
PARAMETER GESPERRT	Do not release	If appropriate release in the release level
PASSWORT FALSCH		Test
TASTATUR VERRIEGELT	Inhibit via binary contact	Check configuration and unlock if necessary
KONFIGURATION WURDE WIEDER HERGESTELLT	Cancel in basic setting	OK
PROFIBUS FEHLER		Check hardware
UNZULÄSSIGE HARDWARE-BESTÜCKUNG		Check fitting, adjust if necessary
FEHLER ECHTZEITUHR: UHRZEIT NEU STELLEN	Instrument had no power supply for a very long time	Establish power supply Set the datalogger time

16 Technical data

Inputs (main board)

Main input	Measuring range/control range	Accuracy	Effect of temperature
pH value	-2 - 16 pH	≤ 0.3% of range	0.2%/10°C
Redox potential	-1500 - 1500 mV	≤ 0.3% of range	0.2%/10°C
NH ₃ (ammonia)	0 - 9999 ppm	≤ 0.3% of range	0.2%/10°C
Secondary input			
Temperature Pt100/1000	-50 to 250°C ¹	≤ 0.25% of range	0.2%/10°C
Temperature NTC/PTC	0.1 - 30 kΩ Entry via table with 20 value pairs	≤ 1.5% of range	0.2%/10°C
Standard signal	0(4) - 20 mA or 0 - 10 V	0.25% of range	0.2%/10°C
Resistance transmitter	Minimum: 100 Ω Maximum: 3 kΩ	+/- 5 Ω	0.1%/10°C

¹ Selectable in °F.

Resistance thermometer inputs (optional board)

Designation	Connection type	Measuring range	Measuring accuracy		Effect of ambient temperature
			3-wire/4-wire	2-wire	
Pt100 DIN EN 60751 (factory-set)	2-wire/3-wire 4-wire	-200 - +850°C	≤ 0.05%	≤ 0.4%	50 ppm/°C
Pt1000 DIN EN 60751 (factory-set)	2-wire/3-wire 4-wire	-200 - +850°C	≤ 0.1%	≤ 0.2%	50 ppm/°C
Sensor lead resistance	Maximum 30 Ω per line with three- and four-wire circuit				
Measurement current	approx. 250 μA				
Lead compensation	Not required for three- and four-wire circuit. With a 2-wire circuit, lead resistance can be compensated in the software by correcting the process value.				

Standard signals inputs (optional board)

Designation	Measuring range	Measuring accuracy	Ambient temperature effect
Voltage	0(2) - 10 V	≤ 0.05%	100 ppm/°C
Electrical current	0 - 1 V Input resistance R _E > 100 kΩ	≤ 0.05%	100 ppm/°C
Resistance transmitter	Minimum: 100 Ω Maximum: 4 kΩ	+/- 4 Ω	100 ppm/K

Temperature compensation

Measurement variable	Compensation	Range ¹
pH value	Yes	-10 - 150°C
Redox potential	No	Not applicable
NH ₃ (ammonia)	Yes	-20 - +50°C

¹ Note the sensor operating temperature range!

Measuring circuit monitoring

Inputs	Overrange/ underrange	Short circuit	Broken lead
pH value	Yes	Yes ¹	Yes ¹
Redox potential	Yes	No	No
NH ₃ (ammonia)	Yes	No	No
Temperature	Yes	Yes	yes
Voltage	2 - 10 V	Yes	Yes
	2 - 10 V	No	No
Current	4 - 20 mA	Yes	Yes
	0 - 20 mA	No	No
Resistance transmitter	No	No	Yes

16 Technical data

¹ The sensor can be monitored for short circuit and broken lead during the pH measurement by activating the impedance measurement.

Impedance measurement

The impedance measurement can optionally be activated.

Because it depends on some boundary parameters, note the following points:

- Only glass-based sensors are permitted.
- The sensors must be connected directly to the transmitter.
- Only one impedance converter may be used in the measuring circuit!
- The maximum permissible line length between sensor and transmitter is 10 m.
- Liquid resistances are included directly in the measurement results.

We therefore recommend activating the measurement in liquids beginning with a minimum conductivity of about 100 µS/cm.

Binary input

Activation	Floating contact is open: function is not active Floating contact is closed: function is active
Function	Key lock, manual mode, HOLD, HOLD inverse, alarm suppression, freeze measured value, level lock, reset partial quantity, reset total quantity, parameter set changeover

Controller

Controller type	Limit comparators, limit controllers, pulse length controllers, pulse frequency controllers, modulating controllers, continuous controllers
Controller structure	P / PI / PD / PID

Outputs

Relay (changeover) - Contact rating - Contact service life	Basic board	5 A at 240 VAC resistive load 350,000 operations at nominal load/750,000 operations at 1 A
Supply voltage for 2-wire transmitter	Basic board	Electrically isolated, non-controlled DC 17 V at 20 mA, open-circuit voltage approx. DC 25 V
Power supply for ISFET	Optional board	DC +/- 5 V; 5 mA
Power supply for inductive proximity switch	Optional board	DC 12 V; 10 mA
Relay (changeover) - Contact rating - Contact service life	Optional board	8 A at AC 240 V resistive load 100,000 operations at nominal load/350,000 operations at 3A
Relay SPST (normally open) - Contact rating - Contact service life	Optional board	3A at 240VAC resistive load 350,000 operations at nominal load/900,000 operations at 1A
Semiconductor relay - Contact rating - Protective circuit	Optional board	1 A at 240 V Varistor
Semiconductor switch (photo MOS)	Optional board	$U \leq 50 \text{ V AC/DC}$ $I \leq 200 \text{ mA}$
Voltage - Output signals - Load resistance - Accuracy	Optional board	0 - 10 V / 2 - 10 V $R_{\text{load}} \geq 500 \Omega$ $\leq 0.5\%$
Electrical current - Output signals - Load resistance - Accuracy	Optional board	0 - 20 mA / 4 - 20 mA $R_{\text{load}} \leq 500 \Omega$ $\leq 0.5\%$

Display

Type	LC graphic display, blue with background lighting, 122 x 32 pixels
------	--

16 Technical data

Electrical data

Supply voltage (switch-mode PSU)	AC 110 - 240 V -15/+10%; 48 - 63 Hz or AC/DC 20-30 V; 48 - 63 Hz
Electrical safety	to DIN EN 61010, Part 1 overvoltage category II, pollution degree 2
Power consumption	Max. 13 VA
Data backup	EEPROM
Electrical connection	On the back via screw terminals, conductor cross-section up to max. 2.5 mm ²
Electromagnetic Compatibility (EMC) - Interference emission - Immunity to interference	DIN EN 61326-1 Class A to industrial requirements

Enclosure

Enclosure type	Plastic enclosure for panel mounting to DIN IEC 61554 or aluminium field housing, orange
Depth behind panel	90 mm (panel mounting), 137 mm (field housing)
Ambient temperature Storage temperature	-5...+55°C (panel mounting), -5...+50 °C (field housing) -30...+70°C
Climatic rating	Rel. humidity ≤90% annual mean, no condensation
Operating position	Horizontal
Enclosure protection	to DIN EN 60529, front IP65, rear IP20
Weight (fully fitted)	about 380 g (panel mounting), about 1480 g (field housing)

Interface

Modbus	
Interface type	RS422/RS485
Protocol	Modbus, Modbus Integer
Baud rate	9600, 19200, 38400
Device address	0 - 255
Max. number of nodes	32
PROFIBUS-DP	
Device address	0 - 255

17 Retrofitting optional boards



Caution:

The instrument **must** be de-energized on the input and output sides!
Optional boards must only be retrofitted by qualified specialists.





ESD:

Optional boards can be damaged by electrostatic discharge. You must therefore prevent electrostatic charges from accumulating during installation and removal. Optional boards should be retrofitted at a grounded workstation.

17.1 Identifying an optional board

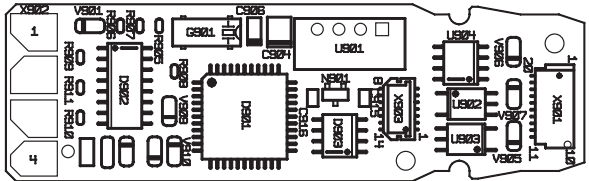
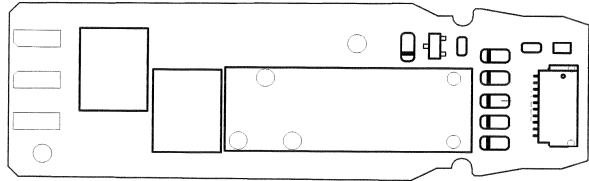
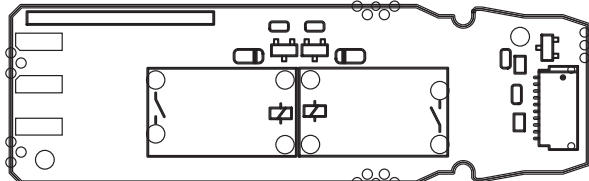
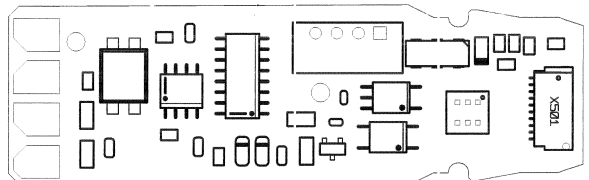
The packaging of the optional board is identified by a sales number.

Optional board	Code	Sales No.	Board view
Analog input (universal)	1	APM-100001	
Relay (1 x changeover)	2	APM-100002	
Relay (2 x NO) This board must only be inserted in optional slot 1 or 3!	3	APM-100003	
Analog output	4	APM-100004	
Two MosFET semiconductor switch	5	APM-100005	

17 Retrofitting optional boards

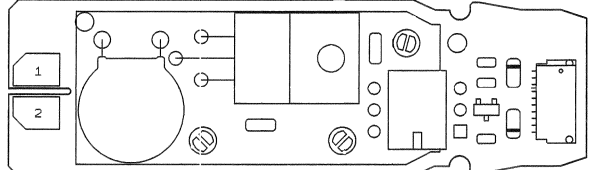
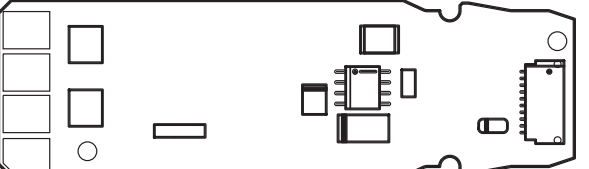
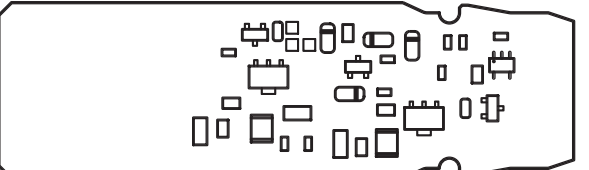
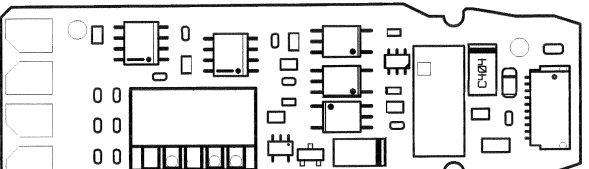
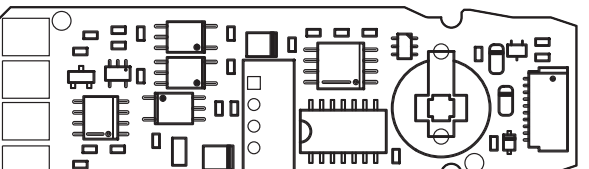
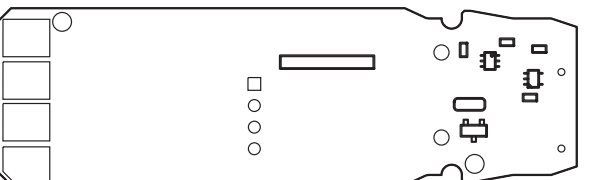
Optional board	Code	Sales No.	Board view
Semiconductor relay 1 A	6	APM-100006	
Supply voltage output +/- 5 V DC (e.g. for ISFET)	7	APM-100007	
Supply voltage output 12 V DC (e.g. for inductive proximity switch)	8	APM-100008	
Interface - RS422/485	10	APM-10000S	
Datalogger with interface RS422/485	11	APM-10000D	
Profibus-DP interface	12	APM-10000P	

17.2 Removing a plug-in module



- (1) Squeeze the front panel together by the left and right sides and remove the plug-in module.

17.3 Inserting a plug-in module



Caution:

No "3" relays (2 x SPST/normally open) may be inserted in slot 2!

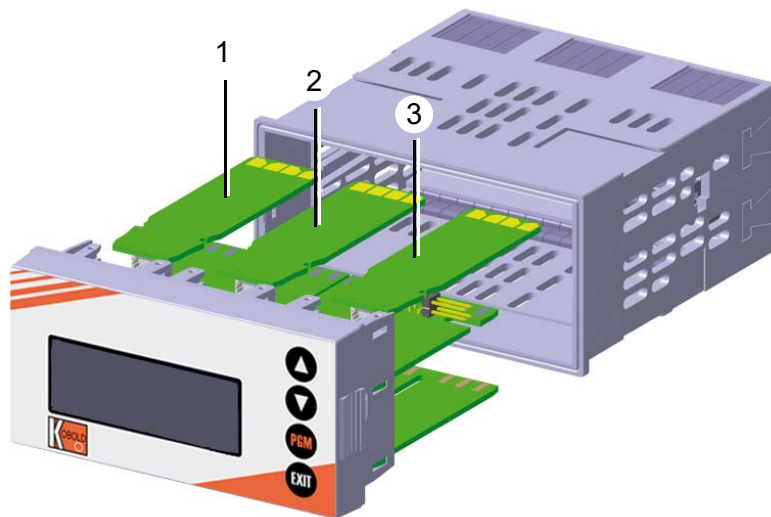

- (1) Slot 1 for optional board
 - (2) Slot 2 for optional board
 - (3) Slot 3 for optional board
- (1) Push the optional board into the slot until it locks in place.
 - (2) Push the device plug-in into the enclosure until it locks in place.

17 Retrofitting optional boards

17.4 Retrofitting optional boards (field housing)

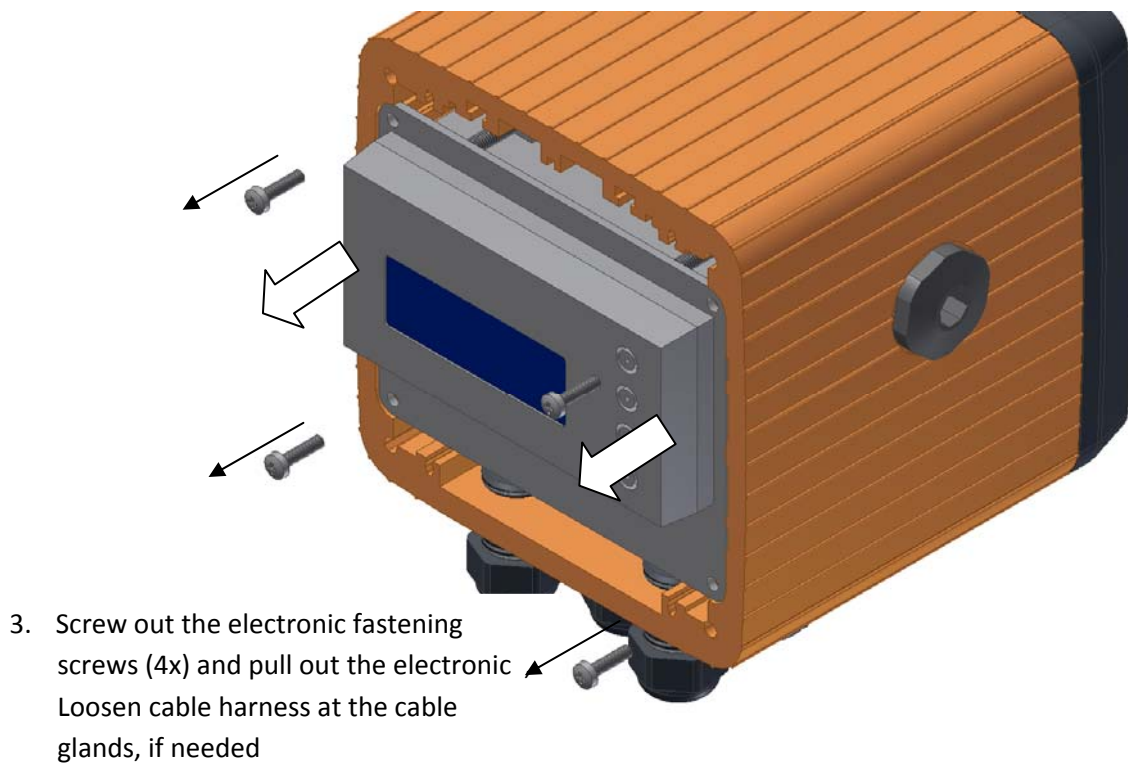

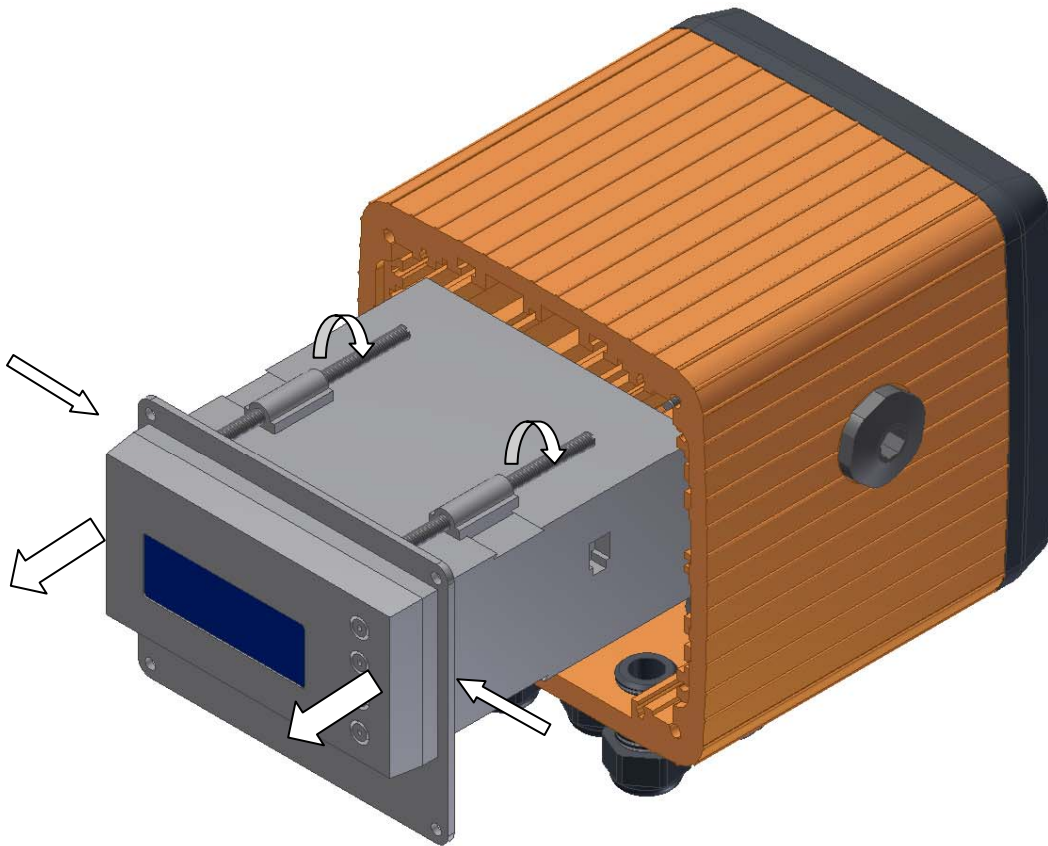

4. Loosen the clamp screws (4x), push back the front plate and press together the latching surface of electronic module from left and right. Pull out the electronic insert from the electronic housing.
5. The optional boards can now be installed in the electronic. The assembly takes place in reverse order. While mounting the front cover on the housing profile, care should be taken to correctly position the gasket in the groove.

18 Appendix

18.1 Glossary

Zero point (1-point) calibration

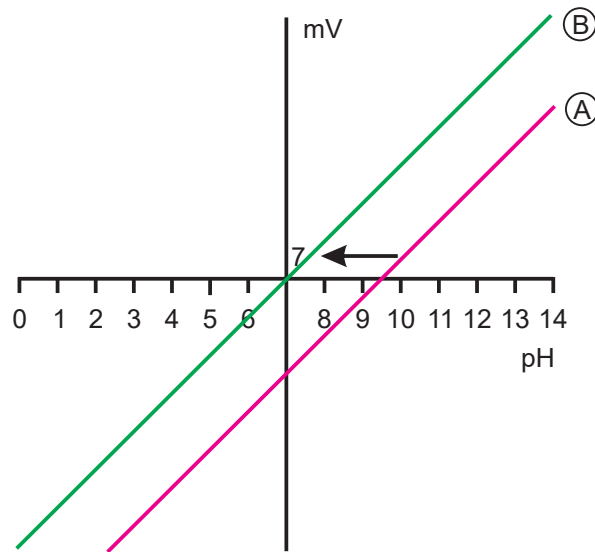

- With one-point offset calibration, the zero point of the pH combination electrode is calculated, See section 8.3 "Zero point (1-point) calibration", page 48.
Recommended only for special applications, such as ultra-pure water.

2-point calibration

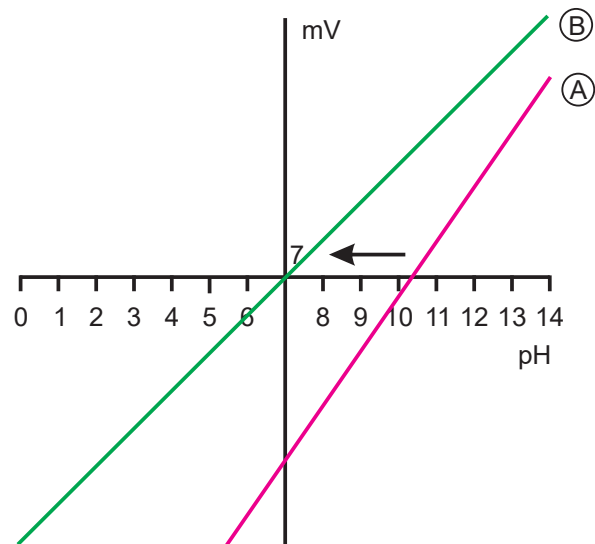



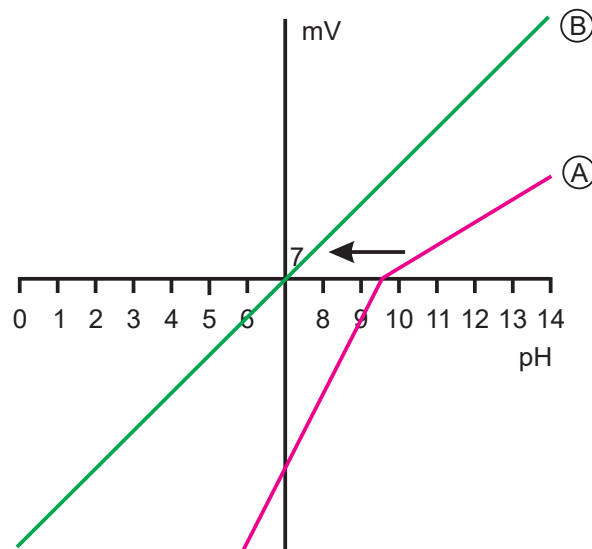

- With two-point calibration, the zero point and slope of the combination electrode are calibrated, See section 8.4 "2-point calibration", page 49.
This is the recommended calibration for most sensors.

3-point calibration

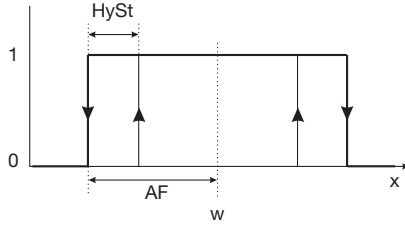

In three-point calibration, the zero point and the slope are calibrated in the acidic range and the slope is calibrated in the alkaline range, See section 8.5 "3-point calibration", page 51. This calibration is recommended with heightened requirements for accuracy.

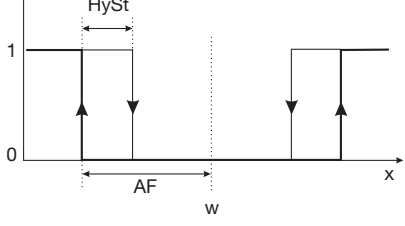
Limit value (alarm) function of the binary outputs

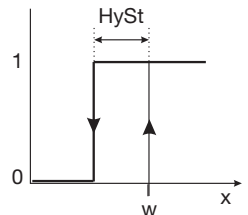
	AF1	
	AF2	
	AF7	

18 Appendix

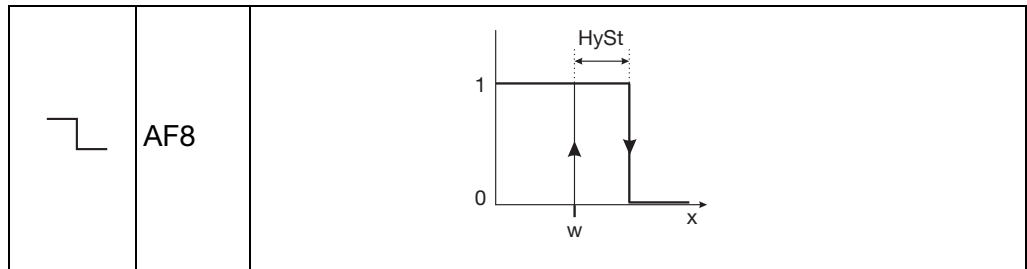

Display of measured values STANDARD

The measurement value, measurement variable and temperature of the measuring material are shown in standard display.

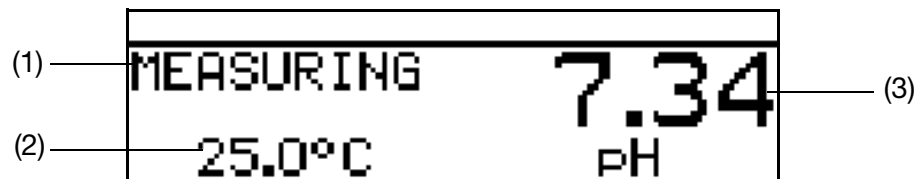

- (1) Operating mode
- (2) Display bottom (temperature input)
- (3) Display top (analog input measurement value)

Display of measured values TENDENCY

The operator can quickly see the direction in which the measurement is changing.

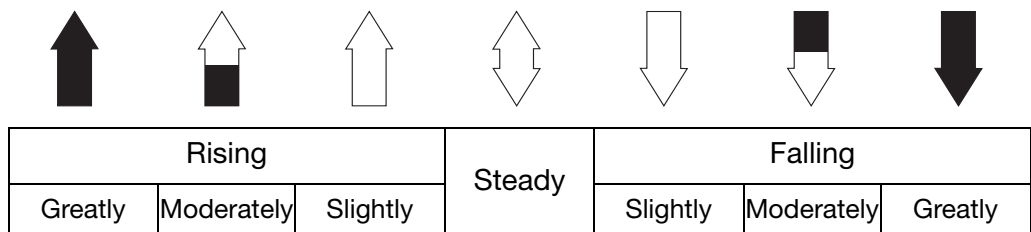
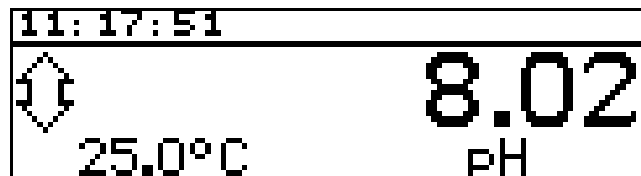

The measurement tendency (trend) is calculated over the last 10 measurement values.

So with a sampling interval of 500 ms, the last 5 seconds are considered.

Display of measured values BARGRAPH

- Values of the main inputs, input options or math channels (signal source) can be represented as a variable bar (a bar graph).



Scaling the bar

- * Activate "BARGRAPH" as the display of measured values.
- * Select "SCALE START" with .
- * Confirm the selection with .
- * Use and to enter the lower limit of the range to be displayed.
- * Confirm the selection with .
- * Select "SCALE END" with .
- * Use or to enter the upper limit of the range to be displayed.
- * Confirm the selection with .



To return to measuring mode:
Press the key repeatedly or wait for a "timeout".

Measurement display type TREND CHART



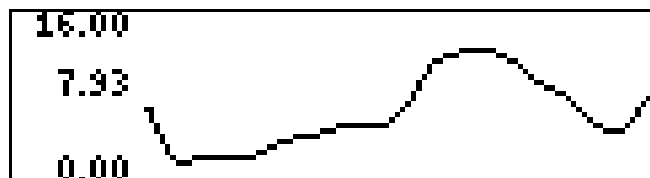

- Values of the main inputs, input options or math channels (signal source) can be represented as a graph.
The current values appear to the right on the screen.



Scaling the display

- * Activate "TREND CHART" as the display of measured values.
- * Select "SCALE START" with .
- * Confirm the selection with .
- * Use and to enter the lower limit of the range to be displayed.

18 Appendix

- * Confirm the selection with .
- * Select "SCALE END" with .
- * Use  or  to enter the upper limit of the range to be displayed.
- * Confirm the selection with .



To return to measuring mode:
Press the  key repeatedly or wait for a "timeout".

Display of measured values LARGE DISPLAY

Values of the main inputs, input options or math channels (signal source) can be displayed in large format.



5.03

Display of measured values 3 MEAS. VALUES

Three values of the main inputs, input options or math channels (signal source) can be displayed simultaneously.

The position of the value to be displayed can be set to "Top", "Center" or "Bottom".

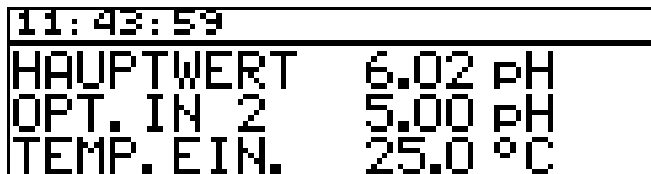

11:43:59	
HAUPTWERT	6.02 pH
OPT. IN 2	5.00 pH
TEMP. EIN.	25.0 °C

Pulse length controller (output active with $x > w$ and P control structure)

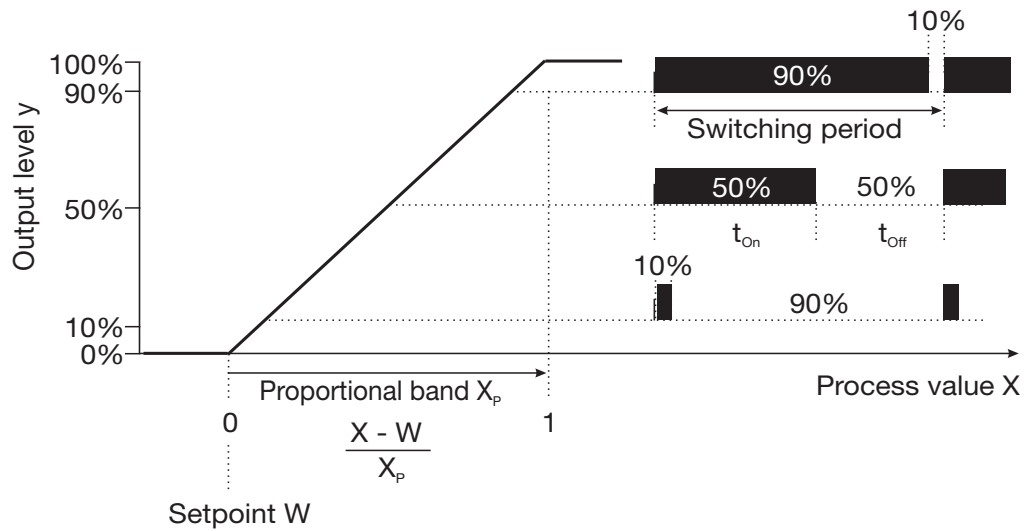

If actual value x exceeds setpoint W , the P controller will control in proportion to the control deviation. When the proportional range is exceeded, the controller operates with an output level of 100% (100% clock ratio).

Pulse frequency controller (output active with $x > w$ and P control structure)

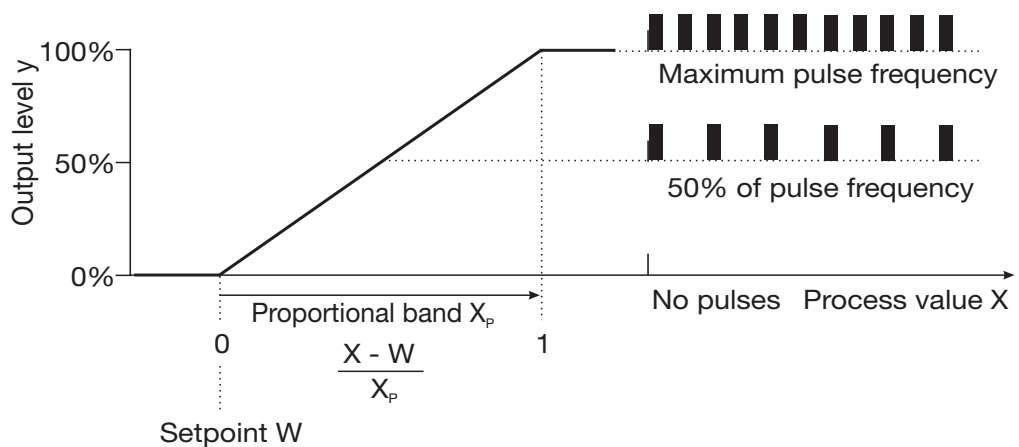

If actual value x exceeds setpoint W , the P controller will control in proportion to the control deviation. When the proportional range is exceeded, the controller operates with an output level of 100% (maximum switching frequency).

Calibration timer

The calibration timer indicates (on request) a required routine calibration. The calibration timer is activated by entering the number of days that must expire before there is a scheduled re-calibration (specified by the system or the operator).

18 Appendix

Customer specs. table

In this mode, the input value can be displayed based on a table (max. 20 value pairs). This function is used to display and linearize non-linear input variables. Values can only be entered in the table using the optional setup program.

Cust. specs. characteristic

In this mode, the instrument can model a monotonically increasing input variable to any output value.

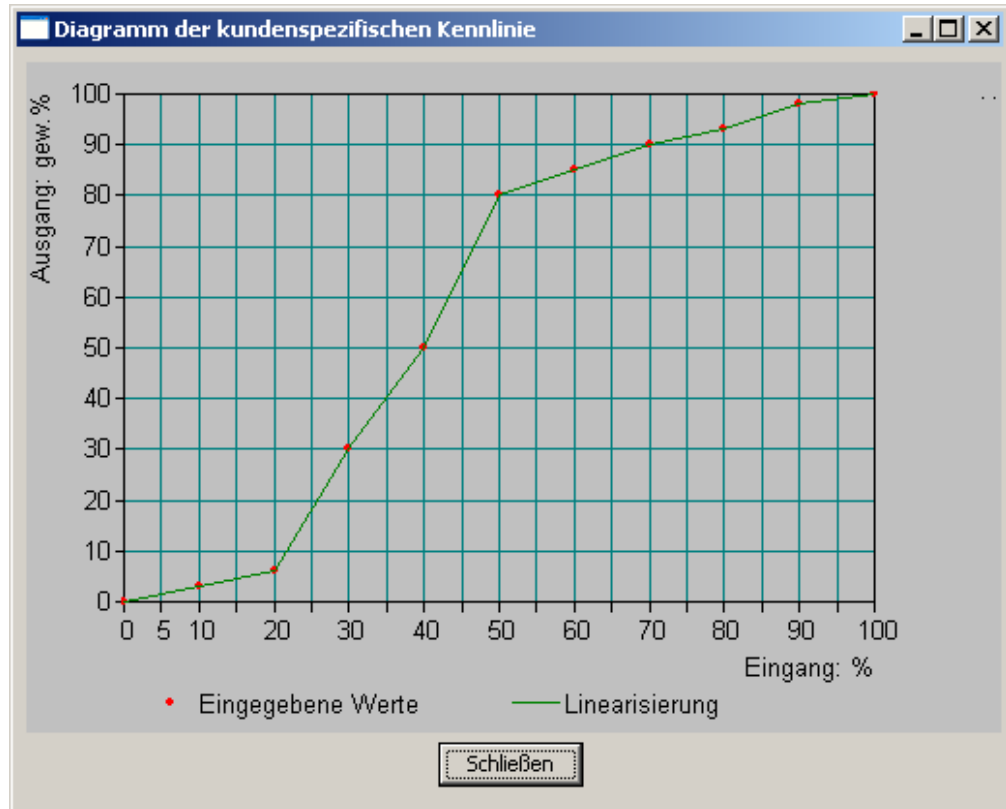

The optional setup program is used to enter the requisite value table.

The figure shows a dialog box titled "Kundenspezifische Kennlinie". It contains a table with two columns: "Eingang" and "Ausgang". The table has 17 rows. The first 11 rows contain data points, and the remaining 6 rows are empty. A "Hinweis" (Note) section on the right provides instructions and ranges for the input and output values. The "OK" and "Abbrechen" buttons are at the bottom right.

	Eingang	Ausgang
4	30	30
5	40	50
6	50	80
7	60	85
8	70	90
9	80	93
10	90	98
11	100	100
12		
13		
14		
15		
16		
17		

Hinweis
Bei der kundenspezifischen Tabelle können Sie maximal 20 Stützstellen in die Tabelle eintragen.
Wertebereich Eingangsgröße: 0.00 ... 100.00 %
Wertebereich Ausgangsgröße: -999.900 ... 999.900 gew.%
Bitte beachten Sie, daß die Eingangsgrößen in ihrem Wert ansteigen müssen.

Min./max. value memory

This storage records the minimum and maximum input quantities that have occurred. This information can be used, for example, to assess whether the design of the connected sensor is suitable for the values that actually occur.

The max./min. value memory can be reset,
See section 6.7.6 "Delete min/max values", page 35:

Temperature compensation

The pH value of a measurement solution depends on the temperature. Since the pH value is not always measured at the reference temperature, the instrument is able to perform a temperature compensation.

The sensor signal for the ammonia measurement is temperature-dependent. The instrument can perform temperature compensation.



The redox potential of a measurement solution is **not** temperature-dependent! Temperature compensation is not required.

Special controller functions: Separate controllers

This function is normally deactivated (factory setting or select "No").

In the deactivated state, the software prevents the two controller outputs from being able to work "against each other". So, for example, it is not possible to dose acid and lye at the same time.

If the controllers are separate ("Yes" selection), each controller can be freely configured.

Switch-off of the I-component

This function is normally deactivated (factory setting or select "No").

In the deactivated state, the controller works in accordance with general controller theory.

When I-component switch-off is activated ("Yes" selection), the part of the output level that can be traced back to the I-component is set to zero when the setpoint is reached.

This can be useful with mutual neutralization (acid and lye dosing both possible) in one treatment tank.

Datalogger

Recording duration = about 10 hours with a storage interval of 1 second

Recording duration = about 150 days with a storage interval of 300 seconds

Asymmetrical connection of pH electrodes

Typically pH electrodes are connected asymmetrically to the transmitter. The connection corresponds exactly to the structure of a pH electrode in terms of impedance.

For the asymmetrical connection, the glass electrode is connected to the electronics with a high impedance and the reference electrode is connected with a low impedance. Most transmitters are designed for this connection type.

For both asymmetrical and symmetrical connections, the input impedance of

18 Appendix

the transmitter is about 1000 times greater than the impedance of the connected glass electrode. The impedance of a glass electrode may be as much as 1000 M Ω .

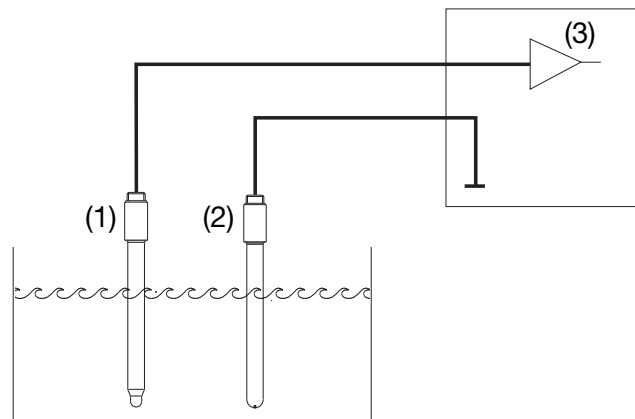

- (1) Glass electrode
- (2) Reference electrode
- (3) Operation amplifier

Symmetrical connection of pH electrodes

The symmetrically high-impedance input is an alternative way to connect pH electrodes to the transmitter. In this case both the glass and the reference electrode are connected to the transmitter with high impedance. With this type of connection, it is essential to connect the liquid junction potential to the transmitter as well.

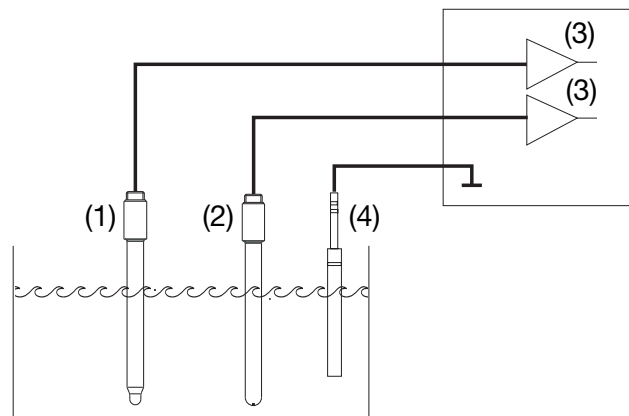

- (1) Glass electrode
- (2) Reference electrode
- (3) Operation amplifier
- (4) Ground pin

Even difficult electrical environmental conditions can be compensated for with the symmetrical connection.

For example, if a poorly insulated electric stirrer motor is directing a residual current into the sample, this will result in a shift in the potential relative to systems ground.

With the normal asymmetrical connection, a residual current can then flow through the coupling capacitances (which are present in all instruments) to systems ground, thereby causing a measurement error.

With a symmetrical connection, both inputs are directed via operation amplifiers to the instrument electronics. These operation amplifiers block the residual current (to a certain degree) and a measuring error is prevented.

Impedance monitoring

Impedance monitoring of glass pH combination electrodes places high demands on the transmitter electronics. The measurement required for this purpose takes place at the same time the main measured value is recorded. To minimize the electrode load, a response time of up to one minute is possible. With an asymmetrical connection of glass and reference electrode, the overall impedance can be monitored.

Monitoring of the reference electrode is not recommended, since the measured value is difficult to interpret.

The impedance measurement depends on the cable material, the line length and the components used. Kobold special lines for pH measurements are limited in length to 10 m.

If ISFET sensors or impedance converters are used, impedance monitoring is not possible.

Wash timer

The wash timer can be used to implement automated sensor cleaning. To do this, the function is assigned to a switching output.

The cycle time (cleaning interval) can be adjusted in the range from 0.0 to 240.0 hours.

A cycle time of "0.0" means the wash timer is deactivated.

The wash time (cleaning duration) is adjustable from 1 to 1800 seconds.

During the wash time the controller goes into the HOLD state, which is maintained for 10 seconds after completion of the wash time. A sensor calibration within the cycle time restarts the wash timer.

18 Appendix

18.2 Parameters of the User level

When there are numerous instrument parameters to configure, it is advisable to make a note in the table below of all the parameters to be changed and to work through these parameters in the given order.



The following list shows the maximum number of parameters that can be modified.

Some of these parameters will not be visible (and therefore not editable) for your particular instrument, depending on the configuration.

Parameter	Selection / value range Factory setting	New setting
Input pH/redox		
Zero point	5.00 - 7.00 - 9.00 or -9999.99 - 0.00 - +9999.99 mV	
Slope - acidic	xx.xx - xx.xx - xx.xx %	
Slope - alkaline	xx.xx - xx.xx - xx.xx %	
Temperature compensation source	Temperature input Option input 1 Option input 2 Option input 3 Manual temperature input	
Monitoring of the reference electrode	Off On	
Glass electrode monitoring	Off On	
Filter time constant	0.0 - 2.0 - 25.0 seconds	
Calibration interval	0 - 99 days (0 = timer not active)	
Differential measurement	Off Main input - (minus) Option input 1 Main input - (minus) Option input 2 Main input - (minus) Option input 3 Option input 1 - (minus) Main input Option input 2 - (minus) Main input Option input 3 - (minus) Main input	
Supply frequency	50 Hz 60 Hz	
Temperature input		
Temperature sensor	No sensor Pt 100 Pt 1000 Cust. specs. 0 - 20 mA 4 - 20 mA 0 - 10 V 2 - 10 V Resistance transmitter	

Parameter	Selection / value range Factory setting	New setting
Unit	°C/°F % Without unit Cust. specs.	
Scaling start	-100.0 - 0.0 - 499.9°C	
Scaling end	-99.9 - 100.0 - 500.0°C	
Filter time constant	0.0 - 2.0 - 25.0 seconds	
Manual temperature	-99.9 - 25.0 - +99.9°C	
Offset	-99.9 - 0.0 - +99.9°C	
Input options		
Analog inputs 1 to 3		
Operating mode	Off Linear Temperature pH measurement Conductivity Concentration Cust. specs. Stroke feedback Chlorine, pH-compensated	
Signal type	0 - 20 mA 4 - 20 mA 0 - 10 V 2 - 10 V 0 - 1 V Pt100 Pt1000 Cust. specs.	
Connection type	2-wire 3-wire 4-wire	
Display format	XXXX XXX.x XX.xx X.xxx	
Unit	µS/cm mS/cm kΩ*cm MΩ*cm None Cust. specs. mV pH % ppm mg/l	
Scaling start	-9999 - +9998	
Scaling end	-9998 ... +9999	





18 Appendix

Parameter	Selection / value range Factory setting	New setting
Temperature compensation source	Temperature input Option input 1 Option input 2 Option input 3 Manual temperature	
pH compensation source	Main input Option input 1 Option input 2 Option input 3	
Temperature compensation	None Linear TC graph Natural waters ASTM D1125 neutral ASTM D1125 acidic ASTM D1125 alkaline NaOH 0 - 12% NaOH 25 - 50% HNO ₃ 0 - 25% HNO ₃ 36 - 82% H ₂ SO ₄ 0 - 28% H ₂ SO ₄ 36 - 85% H ₂ SO ₄ 92 - 99% HCl 0 - 18% HCl 22 - 44%	
Reference temperature	15.0 - 25.0 - 30.0°C	
Filter time constant	0.0 - 2.0 - 25.0 seconds	
Relative cell constant	20.0 - 100.0 - 500.0 1/cm	
Temperature coefficient	0.00 - 2.20 - 8.00 1/cm	
Zero point	-9999 - 0 - +9999	
Slope	-999.9 - 100.0 - +999.9%	
Binary inputs		
Binary input 1 or 2		
Function	No function Manual mode Hold mode Hold mode inverse Alarm stop Freeze measured value Key lock Lock levels Flow rate measurement Reset day counter Reset total counter Parameter set switchover	

Parameter	Selection / value range Factory setting	New setting
Controllers		
Controller 1 or 2		
Parameter set 1 or 2		
Min. setpoint	-2.00 - 0.00 - 16.00 pH	
Max. setpoint	-2.00 - 16.00 - 16.00 pH	
Setpoint	-2.00 - 0.00 - 16.00 pH	
Setpoint 2	-2.00 - 0.00 - 16.00 pH	
Proportional range	0.00 - 99.99 pH	
Reset time	0.00 - 9999 s	
Derivative time	0.00 - 9999 s	
Period time	2.00 - 60.0 - 999.9 s	
Hysteresis	0.00 - 1.00 - 9.00 pH	
On-delay	0.00 - 999.5 s	
Delayed release	0.00 - 999.5 pH	
Output limit	0 - 100%	
Min. turn-on time	0.20 - 0.50 - 99.50 s	
Actuator time	10 - 60 - 3000 s	
Max. pulse frequency	1 - 60 - 80 1/s	
Alarm tolerance	0.00 - 1.00 - 9.00 pH	
Alarm delay	0.00 - 9999 s	
Configuration		
Controller type	Off Limit value Pulse lengths Pulse frequency Continuous Modulating	
Controller actual value	Main value Not comp. Main value Temperature Option input 1 Option input 1 not compensated Option input 2 Option input 2 not compensated Option input 3 Option input 3 not compensated Math 1 Math 2 Differential signal	

18 Appendix

Parameter	Selection / value range Factory setting	New setting
Stroke retransmission	No signal Main value Not comp. Main value Temperature Option input 1 Option input 1 not compensated Option input 2 Option input 2 not compensated Option input 3 Option input 3 not compensated Math 1 Math 2	
Additive disturbance	No signal Main value Not comp. Main value Temperature Option input 1 Option input 1 not compensated Option input 2 Option input 2 not compensated Option input 3 Option input 3 not compensated Math 1 Math 2	
Multiplicative disturbance	No signal Main value Not comp. Main value Temperature Option input 1 Option input 1 not compensated Option input 2 Option input 2 not compensated Option input 3 Option input 3 not compensated Math 1 Math 2	
Min/max contact	Min contact Max contact	
Make/break contact	Make contact Break contact	
Hold mode	0% 100% Frozen Hold output	
Hold reg. ratio	0 - 100%	
Error	0% 100% Frozen Hold output	

Parameter	Selection / value range Factory setting	New setting
Alarm control	Off On	
Controller special functions		
I-switch-off	Inactive (the controller is working normally) Active (special behavior)	
Separate controllers	No Yes	
Manual mode	Locked Coding Switching	
Limit value control		
Limit values 1 to 4		
Signal source	No signal Main value Not comp. Main value Temperature Option input 1 Option input 1 not compensated Option input 2 Option input 2 not compensated Option input 3 Option input 3 not compensated Math 1 Math 2 Differential signal Flow rate Partial quantity Total quantity Output controller 1 Output controller 2 Setpoint 1 controller 1 Setpoint 2 controller 1 Setpoint 1 controller 2 Setpoint 2 controller 2	
Switching function	Alarm function  (AF1) Alarm function  (AF2) Alarm function  (AF7) Alarm function  (AF8)	
Switching point	2.00 - 0.00 - 16.00 pH	
Hysteresis	0.00 - 9.00 pH	

18 Appendix

Parameter	Selection / value range Factory setting	New setting
Binary outputs		
Binary outputs 1 to 8		
Signal source	No signal Limit value control 1 Limit value control 2 Limit value control 3 Limit value control 4 Controller 1 output 1 Controller 1 output 2 Controller 2 output 1 Controller 2 output 2 Controller alarm 1 Controller alarm 2 Controller alarm Sensor warnings Sensor error Warnings and errors Calibration timer Wash timer Logic 1 Logic 2 Autorange	
At calibration	Standard operation Inactive Active Frozen	
Error	Inactive Active Frozen	
Hold mode	Inactive Active Frozen Standard operation	
Switch-on delay	0.0 - 3600 s	
Switch-off delay	0.0 - 3600 s	
Pulse time ¹	0.0 - 3600 s	
Manual mode	No simulation Inactive Active	

¹ Delayed release is automatically deactivated when wiper times are greater than 0 seconds.

Parameter	Selection / value range Factory setting	New setting
Analog outputs		
Analog outputs 1 to 3		
Signal source	No signal Main value Not comp. Main value Temperature Option input 1 Option input 1 not compensated Option input 2 Option input 2 not compensated Option input 3 Option input 3 not compensated Math 1 Math 2 Differential signal Flow rate Partial quantity Total quantity Output controller 1 Output controller 2 Setpoint 1 controller 1 Setpoint 2 controller 1 Setpoint 1 controller 2 Setpoint 2 controller 2	
Signal type	0 - 20 mA 4 - 20 mA 20 - 0 mA 20 - 4 mA 0 - 10 V 10 - 0 V	
Scaling start	2.00 - 0.00 - 15.00 pH	
Scaling end	0.00 - 16.00 pH	
At calibration	Moving Frozen Safe value	
In case of error (output signal, of the controller in case of error)	0/4 mA / 0 V 20 mA / 10 V Frozen Safety value	
Hold mode (output signal, of the controller in Hold mode)	Frozen Safety value Standard mode 0/4 mA / 0 V 20 mA / 10 V	
Safety value	0.0 - 20.0 mA	
Simulation	Off On	
Simulation value	Off 0.0 - 20.0 mA	

18 Appendix

Parameter	Selection / value range Factory setting	New setting
Interface		
Modbus address	1 - 254	
Baud rate	9600 19200 38400	
Parity	None Even Odd	
Stop bits	1 2	
Profibus address	0 - 99	
EEPROM marking	Off On	
Wash timer		
Cycle time	0.0 - 240.0 hours (0.0 = Wash contact is not active)	
Wash time	1 - 60 - 1800 seconds	
Datalogger		
Storage interval	1 - 60 - 300 seconds	
Channels 1 to 4	No signal Main value (standard for channel 1) Not comp. Main value Temperature (standard for channel 2) Option input 1 Option input 1 not compensated Option input 2 Option input 2 not compensated Option input 3 Option input 3 not compensated Math 1 Math 2 Differential signal Flow rate Partial quantity Total quantity Output controller 1 (standard for channel 3) Output controller 2 (standard for channel 4) Setpoint 1 controller 1 Setpoint 2 controller 1 Setpoint 1 controller 2 Setpoint 2 controller 2	
Date year	20xx	
Date month	1 - 12	
Date day	1 - 31	
Time hour	0 - 24	
Time minute	0 - 59	
Time second	0 - 59	

18 Appendix

Parameter	Selection / value range Factory setting	New setting
Display		
Lighting	On With operation	
Display of measured value	Standard Tendency Bargraph Trend chart Large display 3 measured values Time	
Display Top / Center / Bottom	No signal Main value (standard for "Top") Not comp. Main value Temperature (standard for "Center" and "Bottom") Option input 1 Option input 1 not compensated Option input 2 Option input 2 not compensated Option input 3 Option input 3 not compensated Math 1 Math 2 Differential signal Flow rate Partial quantity Total quantity Output controller 1 Output controller 2 Setpoint 1 controller 1 Setpoint 2 controller 1 Setpoint 1 controller 2 Setpoint 2 controller 2	
Operating timeout	0 - 1 - 10 minutes (0 = operating timeout is turned off)	
Scaling start	-2.00 - 0.00 - 15.00 pH	
Scaling end	0.00 - 16.00 pH	

18 Appendix

Parameter	Selection / value range Factory setting	New setting
Signal source	Main value Not comp. Main value Temperature Option input 1 Option input 1 not compensated Option input 2 Option input 2 not compensated Option input 3 Option input 3 not compensated Math 1 Math 2 Differential signal Flow rate Partial quantity Total quantity	
Temperature unit	°C °F	
LCD inverse	Off On	
Contrast	0 - 10 - 20	

19. Disposal

Note!

- Avoid environmental damage caused by media-contaminated parts
- Dispose of the device and packaging in an environmentally friendly manner
- Comply with applicable national and international disposal regulations and environmental regulations.

Batteries

Batteries containing pollutants are marked with a sign consisting of a crossed-out garbage can and the chemical symbol (Cd, Hg, Li or Pb) of the heavy metal that is decisive for the classification as containing pollutants:

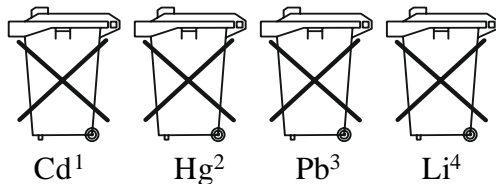

1. „Cd" stands for cadmium
2. Hg" stands for mercury
3. „Pb" stands for lead
4. Li" stands for lithium

Electrical and electronic equipment

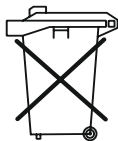

20 EU Declaration of Conformance

20. EU Declaration of Conformance

We, KOBOLD Messring GmbH, Hofheim-Ts, Germany, declare under our sole responsibility that the product:

Transmitter/Controller for pH-Value, Redox, Standard signals and Temperature Model: APM-1

to which this declaration relates is in conformity with the standards noted below:

EN 61326-1:2013 Electrical equipment for measurement, control and laboratory use - EMC requirements - Part 1: General requirements

EN 61010-1:2010+A1:2019/AC:2019 Safety requirements for electrical equipment for measurement, control and laboratory use - Part 1: General requirements

Also the following EU guidelines are fulfilled:

2014/30/EU	EMC Directive
2014/35/EU	Low Voltage Directive
2011/65/EU	RoHS
2015/863/EU	Delegated Directive (RoHS III)

Hofheim, 08 March 2022



H. Volz
General Manager



M. Wenzel
Proxy Holder

21 UK Declaration of Conformance

21. UK Declaration of Conformance

We, KOBOLD Messring GmbH, Hofheim-Ts, Germany, declare under our sole responsibility that the product:

Transmitter/Controller for pH-Value, Redox, Standard signals and Temperature Model: APM-1

to which this declaration relates is in conformity with the standards noted below:

BS EN 61326-1:2013 Electrical equipment for measurement, control and laboratory use - EMC requirements - Part 1: General requirements

BS EN 61010-1:2010+A1:2019/AC:2019 Safety requirements for electrical equipment for measurement, control and laboratory use - Part 1: General requirements

Also the following UK guidelines are fulfilled:

S.I. 2016/1091 Electromagnetic Compatibility Regulations 2016

S.I. 2016/1101 Electrical Equipment (Safety) Regulations 2016

S.I. 2012/3032 The Restriction of the Use of Certain Hazardous Substances in Electrical and Electronic Equipment Regulations 2012

Hofheim, 08 March 2022



H. Volz
General Manager



M. Wenzel
Proxy Holder

Manufactured and sold by:

Kobold Messring GmbH
Nordring 22-24
D-65719 Hofheim
Tel.: +49(0)6192-299-0
Fax: +49(0)6192-23398
E-Mail: info.de@kobold.com
Internet: www.kobold.com

Version: K06/1022