



Diaphragm Seals for Pressure Gauges



measuring
•
monitoring
•
analysing

DRM



- Measuring ranges:
0-1 bar ... 0-1600 bar
- t_{\max} : 350 °C
- Protection of the measuring device against aggressive, highly viscous, solidifying or crystallising media
- Transmission lines enable high temperatures of the media to be measured
- Protection of the measuring device against vibrations by use of capillary tube
- Cavity free measuring points for special hygienic conditions
- Damping of pressure changes and pressure peaks



P1

KOBOLD companies worldwide:

AUSTRALIA, AUSTRIA, BELGIUM, BULGARIA, CANADA, CHINA, CZECHIA, FRANCE, GERMANY, GREAT BRITAIN, HUNGARY, INDIA, INDONESIA, ITALY, MALAYSIA, MEXICO, NETHERLANDS, PERU, POLAND, REPUBLIC OF KOREA, RUSSIA, SPAIN, SWITZERLAND, THAILAND, TUNISIA, TURKEY, USA, VIETNAM

KOBOLD Messring GmbH
Nordring 22-24
D-65719 Hofheim/Ts.
Head Office:
+49(0)6192 299-0
+49(0)6192 23398
info.de@kobold.com
www.kobold.com



Description

Diaphragm seals are partitions for pressure gauges that prevent the material being measured penetrating the measuring system. For measuring pressure in the food industry the use of diaphragm seals is mostly indispensable. With the right choice of diaphragm seal systems it is possible to solve measuring problems that can often not be overcome with the pressure gauge alone.

Application

KOBOLD membrane diaphragm seals are used when the pressure gauge cannot stand up to the requirements of the measuring position. Diaphragm seals transmit the pressure to be measured over that of the transmission liquid that is separated from the medium to be measured by means of the membrane. The transmitted pressure affects the pressure gauge, pressure switch or pressure sensor. The diaphragm seals can be connected to the pressure gauge either directly or indirectly using a transmission line. Diaphragm seal and pressure gauge are joined together at the works to create one unit. Assembly and adjustment are carried out with extreme precision and years of experience.

Areas of Application:

- Media enriched with solids
- Crystallising measured medium
- Polymerising measured medium
- HMh viscosity measured medium
- Corrosive measured medium
- Toxic and environmentally hazardous measured medium
- Very low measured medium temperature
- Very high measured medium temperature
- Hygienic requirements for the food and pharmaceutical sector
- Batch changing without product residues in the measuring system

Construction Type

We mainly manufacture diaphragm seals with every conceivable connecting system. Tongue and Bourdon diaphragm seals fill the gaps to cover all the requirements of the measuring point. KOBOLD diaphragm seals cover every type of assembly, whether with internal or external screw thread, or with coupling rings, clamp or flange mounting. Our tongued diaphragm seals are used when the measuring point only provides a very restricted space.

Our Bourdon diaphragm seals measure the pressure within the pipe through which the measured medium flows. The type of construction means that the diaphragm seal can be kept very sterile. We are constantly developing new diaphragm seals and improving our existing models.

Characteristics

A diaphragm seal barely influences the characteristics of a pressure gauge. The following items do influence them:

Fill and work volumes

The diaphragm seals only contain the minimum amount of pressure transmission liquid required for temperature and

pressure. This volume covers what is needed for the pressure gauge, the compressibility and the thermal expansion.

Membrane

The membranes used are optimally coordinated with the corresponding diaphragm seals.

Transmission line

Reduced volume transmission lines are used to keep the influence on the measuring system as small as possible. Transmission lines are however indispensable for high measured media temperatures, pressure or system pulsation or for unfavourably positioned measuring points.

Pressure Transmission Liquid

The pressure transmission liquid transmits the pressure from diaphragm seal to pressure gauge. There are various liquids that can be used, depending on the operational conditions. All these liquids fulfil the requirement for minimum compressibility and lowest thermal expansion. Glycerine (up to +80 °C) and liquid paraffin (from -10 to +120 °C) are used as siliconefree liquids. Silicone oils are available for temperature ranges from -40 to +200 °C, -20 to +350 °C and -20 to +400 °C. For special applications we can also fill the gauges with MF 7 (Hg, -20 to +350 °C).

In the choice of liquid not all factors can be taken into consideration because, depending on the application, other requirements have to be met, such as food safety specs or that they must be absolutely siliconefree. Our process technicians can choose the best pressure transmission liquid for the requirements.

Operating Conditions

Since the proper pressure indication depends on the temperature of the filling liquid the pressure gauge with diaphragm seals can be adjusted for the operating conditions. To keep these errors to a minimum, the measuring systems are configured to suit the ambient and measured medium temperatures of the application. Without readings the gauges are as standard calibrated to a temperature of +20 °C (± 2 °C). Gauges with a transmission line are set without a height differential between gauge and diaphragm seal. Other height differentials must be stated when ordering because this greatly influences the accuracy of measurement, especially within small measuring ranges.

Materials

All diaphragm seals are made of 1.4571 or 1.4404 stainless steel, as a matter of principle. Other materials can however be used for the membranes or the whole diaphragm seal. It is also possible to coat the diaphragm or the whole diaphragm seal – for example with PFA.

Accessories are listed as of page 14.

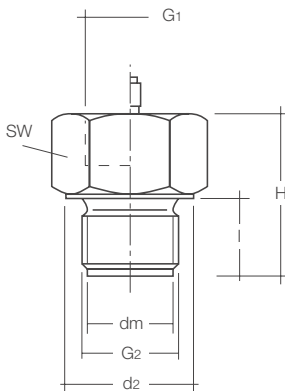

Diaphragm seal DRM-600 / 601 with fixed male thread

Measuring range with sensors: 0 - 1 bar ... 0 - 1000 bar (depending on diaphragm size)
 Suitable devices: SEN-3x/SEN-8x/SEN-98/MAN-Lx/MAN-Sx/PDD/PDA/and others
 Measuring range with manometer: 0-6 bar ... 0-1000 bar (depending on diaphragm size and manometer size)
 Suitable devices: MAN-RD25/27/75/77/MAN-RF2x/MAN-RF7x/and others
 Temperature range: -40 ... +200 °C
 Housing material: stainless steel 1.4571, others on request
 Membrane: flush mounted, stainless steel 1.4571
 Max. length of capillary tube: up to 15 m, if required with armour
 Filling liquid: depending on operating conditions

Model for direct mounting	Model for capillary tube	G2	G1 ¹⁾	dm	SW	d2	I ²⁾	H _{max} ²⁾	Pressure range ³⁾ [bar]	
									min.	max.
DRM-600 R15	DRM-601 R15	G 1/2 M	G 1/2	18	27	27	20	42	0-100	0-1000
DRM-600 R15 R08	--	G 1/2 M	G 1/4	18	27	27	20	42	0-100	0-1000
DRM-600 R20	DRM-601 R20	G 3/4 M	G 1/2	23.8	36	36	20	46	0-40	0-1000
DRM-600 R20 R08	--	G 3/4 M	G 1/4	23.8	36	36	20	46	0-40	0-1000
DRM-600 R25	DRM-601 R25	G 1 M	G 1/2	29.5	41	40.5	20	46	0-10	0-600
DRM-600 R25 R08	--	G 1 M	G 1/4	29.5	41	40.5	20	46	0-10	0-600
DRM-600 R32	DRM-601 R32	G 1 1/4 M	G 1/2	38	50	49.5	20	46	0-6	0-600
DRM-600 R32 R08	--	G 1 1/4 M	G 1/4	38	50	49.5	20	46	0-6	0-600
DRM-600 R40	DRM-601 R40	G 1 1/2 M	G 1/2	40	60	59.5	20	46	0-6	0-600
DRM-600 R40 R08	--	G 1 1/2 M	G 1/4	40	60	59.5	20	46	0-6	0-600
DRM-600 N15	DRM-601 N15	1/2" NPT M	G 1/2	17	27	--	20	42	0-100	0-1000
DRM-600 N15 R08	--	1/2" NPT M	G 1/4	17	27	--	20	42	0-100	0-1000
DRM-600 N20	DRM-601 N20	3/4" NPT M	G 1/2	18	27	--	20	46	0-100	0-1000
DRM-600 N20 R08	--	3/4" NPT M	G 1/4	18	27	--	20	46	0-100	0-1000
DRM-600 N25	DRM-601 N25	1" NPT M	G 1/2	23.8	36	--	20	46	0-40	0-600
DRM-600 N25 R08	--	1" NPT M	G 1/4	23.8	36	--	20	46	0-40	0-600
DRM-600 N32	DRM-601 N32	1 1/4" NPT M	G 1/2	34.5	50	--	20	46	0-6	0-600
DRM-600 N32 R08	--	1 1/4" NPT M	G 1/4	34.5	50	--	20	46	0-6	0-600
DRM-600 N40	DRM-601 N40	1 1/2" NPT M	G 1/2	38	55	--	20	46	0-6	0-600
DRM-600 N40 R08	--	1 1/2" NPT M	G 1/4	38	55	--	20	46	0-6	0-600
DRM-600 M20	DRM-601 M20	M20x1.5 M	G 1/2	18	27	27	20	42	0-100	0-1000
DRM-600 M20 R08	--	M20x1.5 M	G 1/4	18	27	27	20	42	0-100	0-1000
DRM-600 M48	DRM-601 M48	M48x3 M	G 1/2	40	60	59.5	20	46	0-6	0-600
DRM-600 M48 R08	--	M48x3 M	G 1/4	40	60	59.5	20	46	0-6	0-600
		100 °C	200 °C	max. medium temperature						

¹⁾ Only with DRM-600
²⁾ Other sizes on request
³⁾ Guide values for manometer, with sensors from 1 bar

Welding sleeve for DRM-600 / 601

Model	Connection	Height	Version
MZB-R15 A1	G 1/2 F	15 mm	PN 100
MZB-R15 A3	G 1/2 F	34 mm	PN 100
MZB-R20 A1	G 3/4 F	16.5 mm	PN 100
MZB-R20 A3	G 3/4 F	36 mm	PN 100
MZB-R25 A1	G 1 F	19 mm	PN 100
MZB-R25 A4	G 1 F	43 mm	PN 100
MZB-R32 A2	G 1 1/4 F	22 mm	PN 100
MZB-R32 A4	G 1 1/4 F	48 mm	PN 100
MZB-R32 D4	G 1 1/4 F	48 mm	PN 600
MZB-R40 A2	G 1 1/2 F	22 mm	PN 100
MZB-R40 A4	G 1 1/2 F	48 mm	PN 100

Seal for DRM-600 / 601

Model	Material	Size
MZB-DCU R25	copper	for G 1
MZB-DCU R32	copper	for G 1 1/4
MZB-DHD R20	metal + NBR	for G 3/4
MZB-DHD R25	metal + NBR	for G 1
MZB-DHD R32	metal + NBR	for G 1 1/4

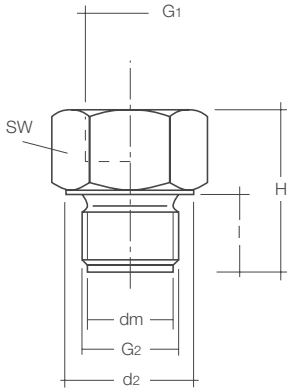

2-part Diaphragm seal DRM-609 with fixed male thread

- Measuring range with sensors: 0 - 1 bar ... 0 - 600 bar
- Suitable devices: SEN-3x/SEN-8x/SEN-98/MAN-Lx/MAN-Sx/PDD/PDA/ and others
- Measuring range with manometer: 0 - 40 bar ... 0 - 600 bar (depending on diaphragm size and manometer size)
- Suitable devices: MAN-RD25/27/75/77/MAN-RF2x/MAN-RF7x/ and others
- Temperature range: -40 ... +120 °C
- Housing material: stainless steel 1.4539, others on request
- Membrane: flush mounted, ECTFE-coated
- Gasket: NBR (standard), others on request
- Max. length of capillary tube: up to 10 m, if required with armour
- Filling liquid: depending on operating conditions

Model for direct mounting	G2	G1 ²⁾	dm	SW	d2	l ¹⁾	H _{max} ¹⁾	Pressure range ²⁾ [bar]	
								min.	max.
DRM-609 R32	G 1¼ M	G ½	23,8	50	49,5	20	46	0-40	0-600

²⁾ Guide values for manometer, with sensors from 1 bar

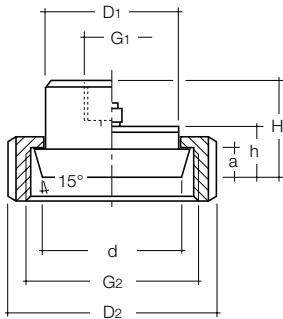

Diaphragm seal DRM-602 / 603 with union nut according to DIN 11851 (sanitary connection)

Measuring range with sensors: 0 - 0,4 bar ... 0 - 40 bar (depending on diaphragm size)
 Suitable devices: SEN-3x/SEN-8x/SEN-98/MAN-Lx/MAN-Sx/PDD/PDA/ and others
 Measuring range with manometer: 0 - 2,5 bar ... 0 - 40 bar (depending on diaphragm size and manometer size)
 Suitable devices: MAN-RD25/27/75/77/MAN-RF2x/MAN-RF7x/ and others
 Temperature range: -40 ... +200 °C
 Housing material: stainless steel 1.4571, others on request
 Diaphragm: flush mounted, stainless steel 1.4571
 Max. length of capillary tube: up to 10 m, if required with protection hose
 Filling liquid: compatible with foodstuffs

Model for direct mounting	Model for capillary tube	G2	D1	D2	G1	DN	d	a	h	H
DRM-602 R20	--	Rd44 x 1/8"	30	54	G 1/2	20	32	8	16	31
DRM-602 R20 R08	--	Rd44 x 1/8"	30	54	G 1/4	20	32	8	16	31
DRM-602 R25	DRM-603 R25	Rd52 x 1/8"	35	63	G 1/2	25	40	8	16	31
DRM-602 R25 R08	--	Rd52 x 1/8"	35	63	G 1/4	25	40	8	16	31
DRM-602 R32	DRM-603 R32	Rd58 x 1/8"	40	70	G 1/2	32	46	11	16	32
DRM-602 R32 R08	--	Rd58 x 1/8"	40	70	G 1/4	32	46	11	16	32
DRM-602 R40	DRM-603 R40	Rd65 x 1/8"	48	78	G 1/2	40	52	11	16	32
DRM-602 R40 R08	--	Rd65 x 1/8"	48	78	G 1/4	40	52	11	16	32
DRM-602 R50	DRM-603 R50	Rd78 x 1/8"	61	92	G 1/2	50	64	11	16	32
DRM-602 R50 R08	--	Rd78 x 1/8"	61	92	G 1/4	50	64	11	16	32
DRM-600 R65	DRM-603 R65	Rd95 x 1/8"	79	112	G 1/2	65	84	13	16	32
DRM-606 R80	DRM-603 R80	Rd110 x 1/4"	93	127	G 1/2	80	96	13	16	32
DRM-600 R1H	DRM-603 R1H	Rd130 x 1/4"	114	148	G 1/2	100	117	13	16	32
		100 °C	200 °C		max. medium temperature					

Diaphragm seal DRM-602G with round thread according to DIN 11851 (for counterpiece with union nut)

Model for direct mounting	Model for capillary tube	G2	D1	D2 ¹⁾	G1	DN	d ²⁾	a	h	H
DRM-602 G25	DRM-603 G25	Rd52 x 1/8"	30	(63)	G 1/2	25	43	11	16	32
DRM-602 G25 R08	--	Rd52 x 1/8"	30	(63)	G 1/4	25	43	11	16	32
DRM-602 G32	DRM-603 G32	Rd58 x 1/8"	32	(70)	G 1/2	32	49	11	16	32
DRM-602 G32 R08	--	Rd58 x 1/8"	32	(70)	G 1/4	32	49	11	16	32
DRM-602 G40	DRM-603 G40	Rd65 x 1/8"	38	(78)	G 1/2	40	55	11	16	32
DRM-602 G40 R08	--	Rd65 x 1/8"	38	(78)	G 1/4	40	55	11	16	32
DRM-602 G50	DRM-603 G50	Rd78 x 1/8"	50	(92)	G 1/2	50	64	11	16	32
DRM-602 R50 G08	--	Rd78 x 1/8"	50	(92)	G 1/4	50	64	11	16	32
		100 °C	200 °C		max. medium temperature					

¹⁾ D2 = existing on customer side only ²⁾ d = start of cone of thread connection

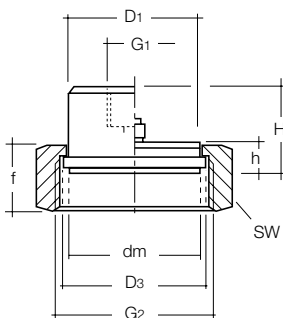

Diaphragm seal DRM-604 / 605 with union nut acc. to IDF standard

Measuring range: 0 - 1 ... 0 - 100 bar (depending on nominal size)
 Temperature range: -10 ... +200 °C (not with electr. transmitter)
 Material: stainless steel 1.4301, st. steel 1.4571, others on request
 Diaphragm: front flush, stainless steel 1.4571
 Max. length of capillary tube: up to 10 m, if required with protection hose
 Filling liquid: compatible with foodstuffs

Model for direct mounting	Model for capillary tube	G2IDF	D1, dm	D3	G1	SW	f	h	H
DRM-604 R25	DRM-605 R25	1"	29.5	33.5	G 1/2	47	30	13	31
DRM-604 R40	DRM-605 R40	1 1/2"	42.5	47	G 1/2	62	30	13	30.5
DRM-604 R50	DRM-605 R50	2"	56	60	G 1/2	77	30	13	30.5
		100 °C	200 °C		max. medium temperature				

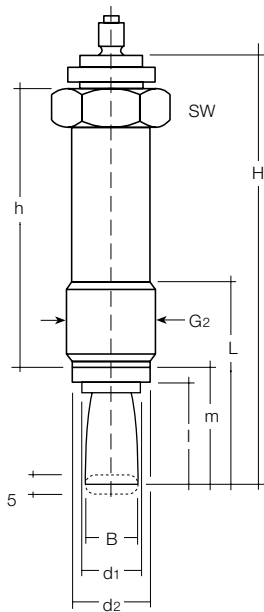

Capsule seal DRM-606, 33 cm long, standard with running nut G 3/4 A, M28x1.5

for capillary connection

Measuring range: 0 - 100 bar ... 0 - 600 bar
 Temperature range: -40 °C ... +350 °C
 Material: stainless steel 1.4571, others on request
 Tongue sensor: stainless steel 1.4571
 Max. length of capillary tube: up to 15 m, if required with protection hose
 Filling liquid: MF 7 recommended

Model for capillary tube	SW	G2	B	d1	d2	l	m	L	h	H
DRM-606 R20	32	G 3/4	16.5	18	24	33	39	67	76	130
DRM-606 R28	32	M28x1,5M	16.5	18	24	33	39	67	76	130

350 °C	max. medium temperature
--------	-------------------------

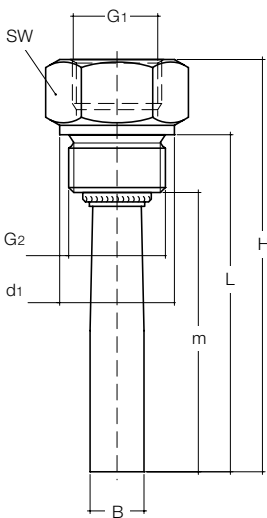

Capsule seal DRM-607 with fixed male thread

Measuring range: 0 - 6 bar ... 0 - 600 bar
 Temperature range: -40 °C ... +100 °C
 Material: stainless steel 1.4301, others on request
 Tongue sensor: stainless steel 1.4571
 Max. length of capillary tube: up to 15 m, if required with protection hose
 Filling liquid: MF 7 recommended

Model for direct mounting	Model for capillary tube	G2	SW	B	G1	d1	m	L	H
DRM-607 R15	-	G 1/2 M	27	16.5	G 1/2	27	94	102	126
DRM-607 R20	-	G 1/2 M	32	16.5	G 1/2	32	94	100	118

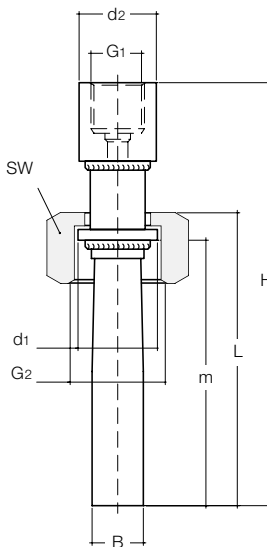

Capsule seal DRM-607 / 1 and DRM-608 / 1 with union nut

Measuring range: 0 - 6 bar ... 0 - 600 bar
 Temperature range: -40 °C ... +350 °C
 Material: stainless steel 1.4301, others on request
 Tongue sensor: stainless steel 1.4571
 Max. length of capillary tube: up to 15 m, if required with protection hose
 Filling liquid: MF 7 recommended

Model for direct mounting	Model for capillary tube	G2	SW	B	G1	d1	d2	m	L	H
DRM-607/1 R20	DRM-608/1 R20	G 3/4 F	32	16.5	G 1/2	23.5	25	85	94	132
DRM-607/1 R25	DRM-608/1 R25	G 1 F	36	16.5	G 1/2	29	25	85	94	132

100 °C	350 °C	max. medium temperature
--------	--------	-------------------------

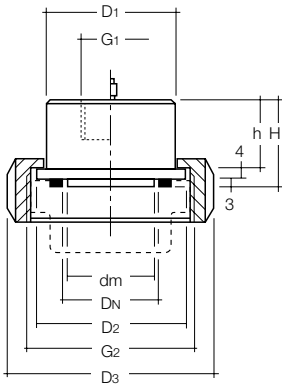

Diaphragm seal DRM-610 / 611 with union nut to SMS standard

Measuring range: 0 - 1 bar ... 0 - 10 bar (depending on nominal size)
 Temperature range: -10 °C ... +200 °C (not with electr. transmitter)
 Material of housing: stainless steel 1.4571, others on request
 Diaphragm: front flush, stainless steel 1.4571
 Max. length of capillary tube: up to 10 m, if required with protection hose
 Filling liquid: compatible with foodstuffs

Model for direct mounting	Model for capillary tube	G2 SMS-Norm	D1	D2	dm	G1	DN	D3	h	H
DRM-610 R40	DRM-611 R40	1½"	47.5	55	34.5	G½	1½"	74	20	27
DRM-610 R50	DRM-611 R50	2"	60	65	45.5	G	2"	84	20	27

100 °C	200 °C	max. medium temperature
--------	--------	-------------------------

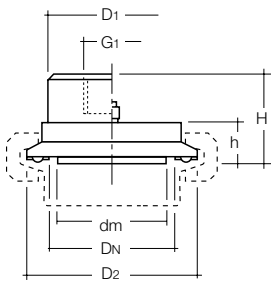

Diaphragm seal DRM-612/613 with clamp connection DIN 32676

Measuring range with sensors: 0-0,4 bar ... 0-16 bar (depending on diaphragm size)
 Suitable devices: SEN-3x/SEN-8x/SEN-98/MAN-Lx/MAN-Sx/PDD/PDA/ and others
 Measuring range with manometer: 0-2,5 ... 0-16 bar (depending on diaphragm size and manometer size)
 Suitable devices: MAN-RD25/27/75/77/MAN-RF2x/MAN-RF7x/ and others
 Temperature range: -10 °C ... 200 °C
 Housing material: stainless steel 1.4571, others on request
 Diaphragm: flush mounted, stainless steel 1.4571
 Max. length of capillary tube: up to 10 m, if required with protection hose
 Filling liquid: compatible with foodstuffs

Model for direct mounting	Model for capillary tube	DN DIN	DN ASME	D1	D2	dm	G1	h	H	PN max.
DRM-612R25	DRM-613R25	25	1"	42.5	50.5	25	G½	10.5	25	16 bar
DRM-612R25R08	--	25	1"	42.5	50.5	25	G¼	10.5	25	16 bar
DRM-612R32	DRM-613R32	32	--	42.5	50.5	29.5	G½	10.5	25	16 bar
DRM-612R32R08	--	32	--	42.5	50.5	29.5	G¼	10.5	25	16 bar
DRM-612R40	DRM-613R40	40	1½"	42.5	50.5	34.5	G½	10.5	25	16 bar
DRM-612R40R08	--	40	1½"	42.5	50.5	34.5	G¼	10.5	25	16 bar
DRM-612R50	DRM-613R50	50	2"	51	64	45.5	G½	10.5	25	16 bar
DRM-612R50R08	--	50	2"	51	64	45.5	G¼	10.5	25	16 bar
DRM-612R65	DRM-613R65	--	2½"	63.5	77.5	52	G½	10.5	25	10 bar
DRM-612R70	DRM-613R70	65	3"	76	91	64	G½	10.5	25	10 bar
DRM-612R80	DRM-613R80	80	--	85	106	64	G½	10.5	25	10 bar
DRM-612R1H	DRM-613R1H	100	4"	104	119	64	G½	10.5	25	10 bar

100 °C	200 °C	max. medium temperature
--------	--------	-------------------------

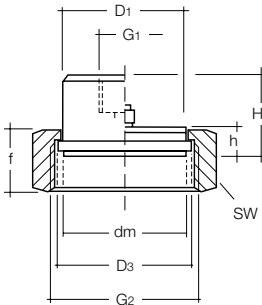

Diaphragm seal DRM-614 / 615 with union nut to APV-RJT standard

Measuring range: 0 - 1 bar ... 0 - 100 bar (depending on nominal size)
 Temperature range: -10 °C ... +200 °C (not with electr. transmitter)
 Material of housing: stainless steel 1.4571, others on request
 Diaphragm: front flush, stainless steel 1.4571
 Max. length of capillary tube: up to 10 m, if required with protection hose
 Filling liquid: compatible with foodstuffs

Model for direct mounting	Model for capillary tube	G2 APV-RJT	D1, dm	D3	G1	SW	f	h	H
DRM-614 R25	DRM-615 R25	1"	29.5	33.5	G ½	47	30	13	31
DRM-614 R40	DRM-615 R40	1½"	42.5	47	G ½	62	30	13	30.5
DRM-614 R50	DRM-615 R50	2"	56	60	G ½	77	30	13	30.5

100 °C	200 °C	max. medium temperature
--------	--------	-------------------------

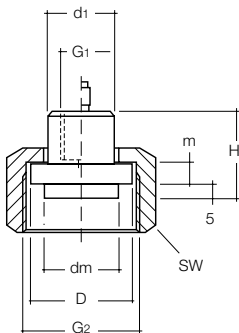

Diaphragm seal DRM-616 / 617 with union nut

Measuring range: 0 - 100 bar ... 0 - 1600 bar
 Temperature range: 0 °C ... +120 °C (not with electr. transmitter)
 Material of housing: stainless steel 1.4571
 Diaphragm: front flush, stainless steel 1.4571
 Max. length of capillary tube: up to 10 m, if required with protection hose
 Filling liquid: MF 8 (foodstuff-compatible) recommended

Model for direct mounting	Model for capillary tube	G2	G1	SW	dm	D	d1	m	H
DRM-616 R45	DRM-617 R45	M45x2	G ¾	55	23.8	33.3	22	6	27

100 °C	120 °C	max. medium temperature
--------	--------	-------------------------

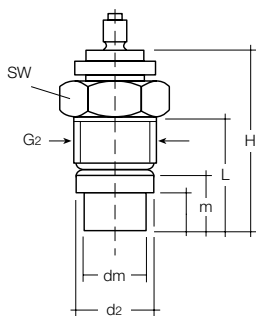

Diaphragm seal DRM-620, Ø 18 mm, rotatable

with running nut for connection of capillary tube

Measuring range: 0 - 100 bar ... 0 - 600 bar
 Temperature range: 0 °C ... +350 °C (not with electr. transmitter)
 Material of housing: stainless steel 1.4571, others on request
 Diaphragm: front flush, stainless steel 1.4571
 Max. length of capillary tube: up to 10 m, if required with protection hose
 Filling liquid: MF 7 recommended

Model for capillary tube	G2	dm	d2	SW	l	m	L	H
DRM-620 R20	G ¾ AG	18	23.8	32	11	17	35	60

350 °C	max. medium temperature
--------	-------------------------

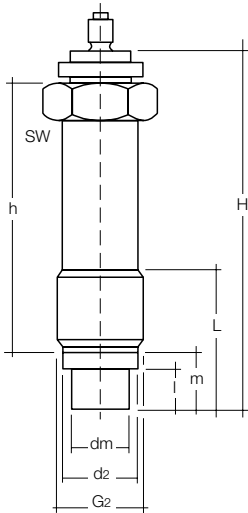

Diaphragm seal DRM-620/1, Ø 18 mm, rotatable, long

with running nut for connection of capillary tube

Measuring range: 0 - 100 bar ... 0 - 600 bar
 Temperature range: 0°C ... +350°C
 Material of housing: stainless steel 1.4571, others on request
 Diaphragm: front flush, stainless steel 1.4571
 Max. length of capillary tube: up to 10 m, if required with protection hose
 Filling liquid: MF 7 recommended

Model for capillary tube	G2	dm	d2	SW	l	m	L	h	H
DRM-620/1 R20	G ¼	18	23.8	32	11	17	45	76	107

350°C	max. medium temperature
-------	-------------------------

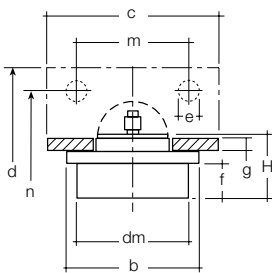

Diaphragm seal DRM-621, Ø 38 mm, rotatable

Measuring range: 0 - 4 bar ... 0 - 25/40 bar
 Temperature range: -20°C ... +250°C (not with electr. transmitter)
 Material of housing: stainless steel 1.4571, others on request
 Diaphragm: front flush, stainless steel 1.4571
 Rectangle flange: material: passivated steel
 Max. length of capillary tube: up to 12 m, if required with protection hose
 Filling liquid: depending on operating conditions

Model for capillary tube	dm	b	c	d	e	f	g	H	m	n
DRM-621 F38	38	45	58	50	6.5	12	6	25	45	35

250°C	max. medium temperature
-------	-------------------------

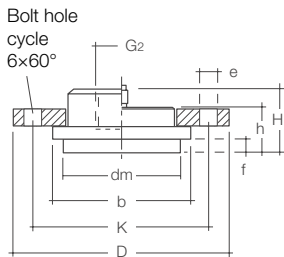

Diaphragm seal Ø 48 mm DRM-622/ -623 with mounting flange

Measuring range with sensors: 0 - 0,4 ... 0 - 40 bar
 Suitable devices: SEN-3x/SEN-8x/SEN-98/MAN-Lx/MAN-Sx/PDD/PDA/ and others
 Measuring range with manometer: 0 - 2,5 ... 0 - 40 bar (depending on manometer size)
 Suitable devices: MAN-RD25/27/75/77/MAN-RF2x/MAN-RF7x/ and others
 Temperature range: -20 ... 200 °C
 Material of housing: stainless steel 1.4571, others on request
 Diaphragm: front flush, stainless steel 1.4571
 Flange: stainless steel Ø 85 LK 70
 Max. length of capillary tube: up to 15 m, if required with protection hose
 Filling liquid: depending on operating conditions

Model for direct mounting	Model for capillary tube	dm	b	D	K	e	f	h	H	G1
DRM-622R15F06	DRM-623000F06	48	58	85	70	7	6.5	18	25	G½
DRM-622R08F06	--	48	58	85	70	7	6.5	18	25	G¼
DRM-622R15F18	DRM-623000F18	48	58	85	70	7	18	29.5	36.5	G½
DRM-622R15F44	DRM-623000F44	48	58	85	70	7	44	55.5	62.5	G½
DRM-622R15F16	DRM-623000F16	48	58	85	70	7	16.5	28	35	G½
DRM-622R15F19	DRM-623000F19	48	58	85	70	7	19.5	31	38	G½

100 °C	200 °C	max. medium temperature
--------	--------	-------------------------

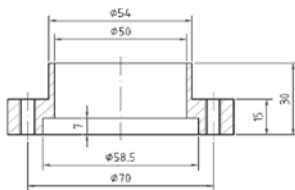

Seal and accessories for DRM-622/-623

Model	Material
MZB-DT1F48	PTFE seal
MZB-DP1F48	Paper seal
DRM-622G	Welded contra flange st. st. with 6 x M6 (f) for measuring adapter 48mm (DRM-622 + DRM-623)
DRM-622L	Contra flange st. st. with 6 x Ø 7 for measuring adapter 48 mm (DRM-622 + DRM-623)
DRM-ZM1	Mounting set 6 pcs VA screws M6 incl. washer and paper seal
DRM-ZM2	Mounting set 6 pcs VA screws M6 incl. washer and PTFE seal

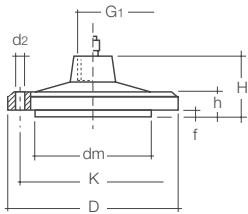

DRM-624...

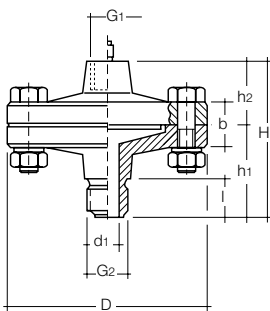

DRM-625...

Diaphragm seal with flange connection DRM-624 / -625 for highly viscous media

Measuring range with sensors: 0 - 0,4 ... 0 - 40 bar

Suitable devices: SEN-3x/SEN-8x/SEN-98/MAN-Lx/MAN-Sx/PDD/PDA/ and others

Meas. range with manometer: 0 - 1,6 ... 0 - 40 bar (depending on manometer size)

Suitable devices: MAN-RD25/27/75/77/MAN-RF2x/MAN-RF7x/and others

Temperature range: -40°C ... 250°C

Material of housing: stainless steel 1.4571, others on request

Connection: front flush or thread with enlarged bore, st. st. 1.4571

Flange: Stainless steel Ø 100 LK 82

Max. length of capillary tube: up to 15 m, if required with protection hose

Filling liquid: depending on operating conditions

Model for direct mounting	Model for capillary tube	G1	G2	D	dm	K	d2	f	b	H	d1	l	h1	h2
DRM-624F1H	DRM-625F1H	G ½ (f)	Ø 100	100	64	82	7	2	8	34.5	--	--	--	--
DRM-624F1HR08	--	G ¼ (f)	Ø 100	100	64	82	7	2	8	34.5	--	--	--	--
DRM-624R08	DRM-625R08	G ½ (f)	G ¼ (m)	100	64	82	--	--	18	76.5	8	16	42	34.5
DRM-624R08R08	--	G ¼ (f)	G ¼ (m)	100	64	82	--	--	18	76.5	8	16	42	30.5
DRM-624R15	DRM-625R15	G ½ (f)	G ½ (m)	100	64	82	--	--	18	80.5	10	20	46	34.5
DRM-624R15R08	--	G ¼ (f)	G ½ (m)	100	64	82	--	--	18	80.5	10	20	46	30.5
DRM-624R20	DRM-625R20	G ½ (f)	G ¾ (m)	100	64	82	--	--	18	80.5	12	20	46	34.5
DRM-624R20R08	--	G ¼ (f)	G ¾ (m)	100	64	82	--	--	18	80.5	12	20	46	30.5
DRM-624R25	DRM-625R25	G ½ (f)	G 1 (m)	100	64	82	--	--	18	80.5	15	20	46	34.5
DRM-624R25R08	--	G ¼ (f)	G 1 (m)	100	64	82	--	--	18	80.5	15	20	46	30.5
DRM-624I15	DRM-625I15	G ½ (f)	G ½ (f)	100	64	82	--	--	18	80.5	10	20	46	34.5
DRM-624I15R08	--	G ¼ (f)	G ½ (f)	100	64	82	--	--	18	80.5	10	20	46	30.5
DRM-624N08	DRM-625N08	G ½ (f)	¼ NPT (m)	100	64	82	--	--	18	76.5	8	16	42	34.5
DRM-624N08R08	--	G ¼ (f)	¼ NPT (m)	100	64	82	--	--	18	76.5	8	16	42	30.5
DRM-624N15	DRM-625N15	G ½ (f)	½ NPT (m)	100	64	82	--	--	18	80.5	10	20	46	34.5
DRM-624N15R08	--	G ¼ (f)	½ NPT (m)	100	64	82	--	--	18	80.5	10	20	46	30.5
DRM-624N20	DRM-625N20	G ½ (f)	¾ NPT (m)	100	64	82	--	--	18	80.5	12	20	46	34.5
DRM-624N20R08	--	G ¼ (f)	¾ NPT (m)	100	64	82	--	--	18	80.5	12	20	46	30.5
DRM-624N25	DRM-625N25	G ½ (f)	1 NPT (m)	100	64	82	--	--	18	80.5	15	20	46	34.5
DRM-624N25R08	--	G ¼ (f)	1 NPT (m)	100	64	82	--	--	18	80.5	15	20	46	30.5
DRM-624A15	DRM-625A15	G ½ (f)	½ NPT (f)	100	64	82	--	--	18	80.5	10	20	46	34.5
DRM-624A15R08	--	G ¼ (f)	½ NPT (f)	100	64	82	--	--	18	80.5	10	20	46	30.5

100 °C	250 °C	max. temperature of medium
--------	--------	----------------------------

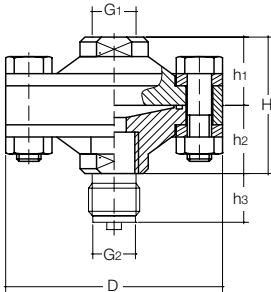

Diaphragm seal DRM-626 / 627 Vario, Ø 90 mm

- Meas. range with sensors: 0 - 0,4 bar ... 0 - 250 bar
- Suitable devices: SEN-3x/SEN-8x/SEN-98/MAN-Lx/MAN-Sx/PDD/PDA/ and others
- Meas. range with manometer: 0 - 2,5 bar ... 0 - 250 bar (depending on manometer size)
- Suitable devices: MAN-RD25/27/75/77/MAN-RF2x/MAN-RF7x/ and others
- Temperature range: -40 °C ... 250 °C
- Material for assembly elements: galvanised steel / stainless steel
- Material for O-ring: FPM (Standard), others on request
- Material diaphragm: stainless steel 1.4571, optional: stainless steel 1.4571 with ECTFE-coating, tantalum, Monel, others on request
- Device connection: G ½ (f), G ¼ (f), capillary tube
- Max. length of capillary tube: up to 10 m, if required with protection hose
- Filling liquid: depending on operating conditions

Model for direct mounting	Model for capillary tube	D	G1	G2	H	H1	H2	H3	PN [bar]
DRM-626R08A025	DRM-627R08A025	90	G ½ (f)	G ¼ (m)	56	28	28	15	25
DRM-626R08A0254		90	G ¼ (f)	G ¼ (m)	56	28	28	15	25
DRM-626R08I025	DRM-627R08I025	90	G ½ (f)	G ¼ (f)	56	28	28		25
DRM-626R08I0254		90	G ¼ (f)	G ¼ (f)	56	28	28		25
DRM-626R10A025	DRM-627R10A025	90	G ½ (f)	G ¼ (m)	56	28	28	18	25
DRM-626R10A0254		90	G ¼ (f)	G ¼ (m)	56	28	28	18	25
DRM-626R15A025	DRM-627R15A025	90	G ½ (f)	G ½ (m)	56	28	28	20	25
DRM-626R15A0254		90	G ¼ (f)	G ½ (m)	56	28	28	20	25
DRM-626R15I025	DRM-627R15I025	90	G ½ (f)	G ½ (f)	56	28	28		25
DRM-626R15I0254		90	G ¼ (f)	G ½ (f)	56	28	28		25
DRM-626R20A025	DRM-627R20A025	90	G ½ (f)	G ¾ (m)	56	28	28	20	25
DRM-626R20A0254		90	G ¼ (f)	G ¾ (m)	56	28	28	20	25
DRM-626R25A025	DRM-627R25A025	90	G ½ (f)	G 1 (m)	56	28	28	20	25
DRM-626R25A0254		90	G ¼ (f)	G 1 (m)	56	28	28	20	25
DRM-626N08A025	DRM-627N08A025	90	G ½ (f)	¼ NPT (m)	56	28	28	15	25
DRM-626N08A0254		90	G ¼ (f)	¼ NPT (m)	56	28	28	15	25
DRM-626N15A025	DRM-627N15A025	90	G ½ (f)	½ NPT (m)	56	28	28	20	25
DRM-626N15A0254		90	G ¼ (f)	½ NPT (m)	56	28	28	20	25
DRM-626N15I025	DRM-627N15I025	90	G ½ (f)	½ NPT (f)	56	28	28		25
DRM-626N15I0254		90	G ¼ (f)	½ NPT (f)	56	28	28		25
DRM-626N20A025	DRM-627N20A025	90	G ½ (f)	¾ NPT (m)	56	28	28	20	25
DRM-626N20A0254		90	G ¼ (f)	¾ NPT (m)	56	28	28	20	25
DRM-626N25A025	DRM-627N25A025	90	G ½ (f)	1 NPT (m)	56	28	28	20	25
DRM-626N25A0254		90	G ¼ (f)	1 NPT (m)	56	28	28	20	25

DRM-626R08A100	DRM-627R08A100	90	G ½ (f)	G ¼ (m)	56	28	28	15	100
DRM-626R08A1004		90	G ¼ (f)	G ¼ (m)	56	28	28	15	100
DRM-626R08I100	DRM-627R08I100	90	G ½ (f)	G ¼ (f)	56	28	28		100
DRM-626R08I1004		90	G ¼ (f)	G ¼ (f)	56	28	28		100
DRM-626R10A100	DRM-627R10A100	90	G ½ (f)	G ¼ (m)	56	28	28	18	25
DRM-626R10A1004		90	G ¼ (f)	G ¼ (m)	56	28	28	18	25
DRM-626R15A100	DRM-627R15A100	90	G ½ (f)	G ½ (m)	56	28	28	20	100
DRM-626R15A1004		90	G ¼ (f)	G ½ (m)	56	28	28	20	100
DRM-626R15I100	DRM-627R15I100	90	G ½ (f)	G ½ (f)	56	28	28		100
DRM-626R15I1004		90	G ¼ (f)	G ½ (f)	56	28	28		100
DRM-626R20A100	DRM-627R20A100	90	G ½ (f)	G ¾ (m)	56	28	28	20	100
DRM-626R20A1004		90	G ¼ (f)	G ¾ (m)	56	28	28	20	100
DRM-626R25A100	DRM-627R25A100	90	G ½ (f)	G 1 (m)	56	28	28	20	100
DRM-626R25A1004		90	G ¼ (f)	G 1 (m)	56	28	28	20	100



Diaphragm seal DRM-626 / 627 Vario, Ø 90 mm (continued)

Model for direct mounting	Model for capillary tube	D	G1	G2	H	H1	H2	H3	PN [bar]
DRM-626N08A100	DRM-627N08A100	90	G ½ (f)	¼ NPT (m)	56	28	28	15	100
DRM-626N08A1004		90	G ¼ (f)	¼ NPT (m)	56	28	28	15	100
DRM-626N15A100	DRM-627N15A100	90	G ½ (f)	½ NPT (m)	56	28	28	20	100
DRM-626N15A1004		90	G ¼ (f)	½ NPT (m)	56	28	28	20	100
DRM-626N15I100	DRM-627N15I100	90	G ½ (f)	½ NPT (f)	56	28	28		100
DRM-626N15I1004		90	G ¼ (f)	½ NPT (f)	56	28	28		100
DRM-626N20A100	DRM-627N20A100	90	G ½ (f)	¾ NPT (m)	56	28	28	20	100
DRM-626N20A1004		90	G ¼ (f)	¾ NPT (m)	56	28	28	20	100
DRM-626N25A100	DRM-627N25A100	90	G ½ (f)	1 NPT (m)	56	28	28	20	100
DRM-626N25A1004		90	G ¼ (f)	1 NPT (m)	56	28	28	20	100

DRM-626R08A250	DRM-627R08A250	90	G ½ (f)	G ¼ (m)	56	28	28	15	250
DRM-626R08A2504		90	G ¼ (f)	G ¼ (m)	56	28	28	15	250
DRM-626R08I250	DRM-627R08I250	90	G ½ (f)	G ¼ (f)	56	28	28		250
DRM-626R08I2504		90	G ¼ (f)	G ¼ (f)	56	28	28		250
DRM-626R10A250	DRM-627R10A250	90	G ½ (f)	G ¼ (m)	56	28	28	18	250
DRM-626R10A2504		90	G ¼ (f)	G ¼ (m)	56	28	28	18	250
DRM-626R15A250	DRM-627R15A250	90	G ½ (f)	G ½ (m)	56	28	28	20	250
DRM-626R15A2504		90	G ¼ (f)	G ½ (m)	56	28	28	20	250
DRM-626R15I250	DRM-627R15I250	90	G ½ (f)	G ½ (f)	56	28	28		250
DRM-626R15I2504		90	G ¼ (f)	G ½ (f)	56	28	28		250
DRM-626R20A250	DRM-627R20A250	90	G ½ (f)	G ¾ (m)	56	28	28	20	250
DRM-626R20A2504		90	G ¼ (f)	G ¾ (m)	56	28	28	20	250
DRM-626R25A250	DRM-627R25A250	90	G ½ (f)	G 1 (m)	56	28	28	20	250
DRM-626R25A2504		90	G ¼ (f)	G 1 (m)	56	28	28	20	250
DRM-626N08A250	DRM-627N08A250	90	G ½ (f)	¼ NPT (m)	56	28	28	15	250
DRM-626N08A2504		90	G ¼ (f)	¼ NPT (m)	56	28	28	15	250
DRM-626N15A250	DRM-627N15A250	90	G ½ (f)	½ NPT (m)	56	28	28	20	250
DRM-626N15A2504		90	G ¼ (f)	½ NPT (m)	56	28	28	20	250
DRM-626N15I250	DRM-627N15I250	90	G ½ (f)	½ NPT (f)	56	28	28		250
DRM-626N15I2504		90	G ¼ (f)	½ NPT (f)	56	28	28		250
DRM-626N20A250	DRM-627N20A250	90	G ½ (f)	¾ NPT (m)	56	28	28	20	250
DRM-626N20A2504		90	G ¼ (f)	¾ NPT (m)	56	28	28	20	250
DRM-626N25A250	DRM-627N25A250	90	G ½ (f)	1 NPT (m)	56	28	28	20	250
DRM-626N25A2504		90	G ¼ (f)	1 NPT (m)	56	28	28	20	250

100°C	250°C	max. medium temperature pressure gauges
80°C	250°C	max. medium temperature pressure sensors

Assembly type up to 25 bar: 4 screws

Assembly type up to 100 bar: 4 screws, supporting ring

Assembly type up to 250 bar: 8 screws, supporting ring

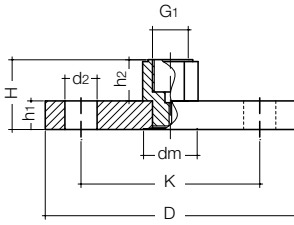

Diaphragm seal with flange connection DRM-628 / 629 to DIN with sealed-in membrane

- Meas. range pressure gauge: 0 - 1.0 bar... 0 - 40 bar*
- Meas. range sensor: 0 - 0.25 bar... 0 - 40 bar*
*(depending on PN and DN of flange)
- Temperature range: -40 °C... +250 °C
- Material flange: stainless steel 1.4571, others on request
- Material diaphragm: stainless steel 1.4571, others on request
- Coating: PFA-coating on request
- Max. length of capillary tube: up to 10 m, if required with protection hose
- Filling liquid: depending on operating conditions
- Connection device: G ½ female thread (G1)

Model for direct mounting	Model for capillary tube	DN	D	K	d2	H	h1	h2	dm	P1 min [bar]	P2 min [bar]	PN
DRM-628 F25 P06	DRM-629 F25 P06	25	100	75	11	37	14	23	24	2.5	-	6
DRM-628 F32 P06	DRM-629 F32 P06	32	120	90	14	37	14	23	30	1.6	-	6
DRM-628 F40 P06	DRM-629 F40 P06	40	130	100	14	37	14	23	38	1.0	4	6
DRM-628 F50 P06	DRM-629 F50 P06	50	140	110	14	37	14	23	48	0.6	2.5	6
DRM-628 F65 P06	DRM-629 F65 P06	65	160	130	14	37	14	23	64	0.25	1.0	6
DRM-628 F80 P06	DRM-629 F80 P06	80	190	150	18	39	16	23	64	0.25	1.0	6
DRM-628 F1H P06	DRM-629 F1H P06	100	210	170	18	39	16	23	64	0.25	1.0	6
DRM-628 F25 P16	DRM-629 F25 P16	25	115	85	14	39	16	23	24	2.5	-	16
DRM-628 F32 P16	DRM-629 F32 P16	32	140	100	18	39	16	23	30	1.6	6	16
DRM-628 F40 P16	DRM-629 F40 P16	40	150	110	18	39	16	23	38	1.0	4	16
DRM-628 F50 P16	DRM-629 F50 P16	50	165	125	18	41	18	23	48	0.6	2.5	16
DRM-628 F65 P16	DRM-629 F65 P16	65	185	145	18	41	18	23	64	0.25	1.0	16
DRM-628 F80 P16	DRM-629 F80 P16	80	200	160	18	43	20	23	64	0.25	1.0	16
DRM-628 F1H P16	DRM-629 F1H P16	100	220	180	18	43	20	23	64	0.25	1.0	16
DRM-628 F25 P40	DRM-629 F25 P40	25	115	85	14	41	18	23	24	2.5	25	40
DRM-628 F32 P40	DRM-629 F32 P40	32	140	100	18	41	18	23	30	1.6	6	40
DRM-628 F40 P40	DRM-629 F40 P40	40	150	110	18	41	18	23	38	1.0	4	40
DRM-628 F50 P40	DRM-629 F50 P40	50	165	125	18	43	20	23	48	0.6	2.5	40
DRM-628 F65 P40	DRM-629 F65 P40	65	185	145	18	45	22	23	64	0.25	1.0	40
DRM-628 F80 P40	DRM-629 F80 P40	80	200	160	18	47	24	23	64	0.25	1.0	40
DRM-628 F1H P40	DRM-629 F1H P40	100	235	190	22	47	24	23	64	0.25	1.0	40

100 °C	250 °C	max. medium temperature pressure gauge
80 °C	250 °C	max. medium temperature pressure sensor

P1 = mounting of pressure sensors
P2 = mounting of pressure gauge

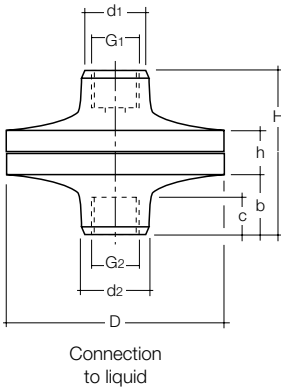

Diaphragm seal DRM-630 / -631 / -632 with variable measuring device connection

- Measuring range with sensors: 0 - 0,25 ... 0 - 10 bar (DRM-630/-631)
0 - 0,25 ... 0 - 16 bar (DRM-632)
- Suitable devices: SEN-3x/SEN-8x/SEN-98/MAN-Lx/MAN-Sx/PDD/PDA/ and others
- Meas. range with manometer: 0 - 1,0 ... 0 - 10 bar (DRM-630/-631)
0 - 1,0 ... 0 - 16 bar (DRM-632)
(depending on manometer size)
- Suitable devices: MAN-RD25/27/75/77/MAN-RF2x/MAN-RF7x/ and others
- Temperature range: 0°C ... 40°C (DRM-630 /631)
0°C ... 50°C (DRM-630 /631)
- Material housing: PVC (Polyvinylchlorid), PP (Polypropylen), PVDF (Polyvinyl-fluorid)
- Material housing screws: stainless steel
- Connection: female or male thread
- Diaphragm: CSM (Hypalon®) with PTFE-coating (others on request)
- Seal: NBR (standard), FKM, EPDM, FFKM
- Max. length of capillary tube: up to 10 m, if required with protection hose
- Filling liquid: depending on operating conditions

Order Details (Example: DRM-632 R15I R08 2)

Material body	Model	Connection process side	d2	Connection meas. device	d1	Seal	D	b	c	h	H
PVC	DRM-630.. max. 10 bar	R08I = G ¼ (f)	32	F00 = capillary tube	32	without= NBR	90	25	18	25	75
		R10I = G ⅜ (f)	32				90	25	18	25	75
		R15I = G ½ (f)	32				90	25	18	25	75
		R15A = G ½ (m)	32				R08 = G ¼ (f)	32	90	25	18
PP	DRM-631.. max. 10 bar	R20I = G ¾ (f)	40	R10 = G ⅜ (f)	32	1 = FKM	90	25	18	25	75
		R25I = G 1 (f)	50	R15 = G ½ (f)	32	2 = EPDM	90	25	18	25	75
		N08I = ¼ NPT (f)	32	N08 = ¼ NPT (f)	32	3 = FFKM	90	25	18	25	75
		N15I = ½ NPT (f)	32	N15 = ½ NPT (f)	32		90	25	18	25	75
PVDF	DRM-632.. max. 16 bar	N15A = ½ NPT (m)	32				90	25	18	25	75
		N20I = ¾ NPT (f)	40				90	25	18	25	75
		N25I = 1 NPT (f)	50				90	25	18	25	75

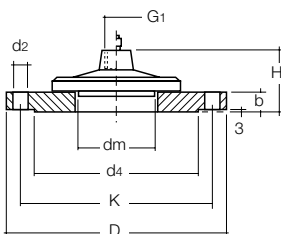

Diaphragm seal with flange connection DRM-633, Ø 100 mm, with open mounting flange DIN 2527 type C

- Measuring range: 0 - 1 bar ... 0 - 40 bar (0 - 6 bar with DN100)
- Temperature range: -40°C ... +250°C
- Material: stainless steel 1.4301, st. steel 1.4571, others on request
- Diaphragm: front flush, stainless steel 1.4571
- Max. length of capillary tube: up to 15 m, if required with protection hose
- Filling liquid: depending on operating conditions

Model for direct mounting	Model for capillary tube	Flange DN/PN	G1	dm	d4	K	D	d2	b	H
DRM-633 F50	DRM-633/1 F50	50/40	G ½	64	102	125	165	18	20	54.5
DRM-633 F1H	DRM-633/1 F1H	100/6	G ½	64	148	210	210	18	16	50.5

100°C	250°C	max. medium temperature
-------	-------	-------------------------

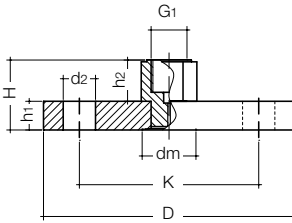

Diaphragm seal with flange connection DRM-634/635 to ANSI B16,5 with sealed-in membrane

- Meas. range pressure gauge: 0 - 15 psi ... 0 - 1500 psi (0 - 1,0 bar ... 0 - 100 bar) depending on PN und DN of flange
- Meas. range sensor: 0 - 4 psi ... 0 - 1500 psi (0 - 0,25 bar ... 0 - 100 bar) depending on PN and DN of flange
- Temperature range: -40 °C ... +250 °C
- Material flange: stainless steel 1.4571, others on request
- Material diaphragm: stainless steel 1.4571, others on request
- Coating: PFA-coating on request
- Max. length of capillary tube: 10 m, if required with protection hose
- Filling liquid: depending on operating conditions
- Connection device: G ½ female thread (G1)

Model for direct mounting	Model for capillary tube	DN	D	K	d2	H	h1	h2	dm	P1 min [psi]	P2 min [psi]	PN [psi]
DRM-634 A25 P150	DRM-635 A25 P150	1"	107.9	76.4	16	37.3	14.3	23	30	25	90	150
DRM-634 A32 P150	DRM-635 A32 P150	1¼"	117.5	88.9	16	38.9	15.9	23	38	15	60	150
DRM-634 A40 P150	DRM-635 A40 P150	1½"	127	98.4	16	40.5	17.5	23	38	15	60	150
DRM-634 A50 P150	DRM-635 A50 P150	2"	152.4	120.6	19	42	19	23	48	10	40	150
DRM-634 A65 P150	DRM-635 A65 P150	2½"	177.8	139.7	19	45.2	22.2	23	48	10	40	150
DRM-634 A80 P150	DRM-635 A80 P150	3"	190.5	152.4	19	46.8	23.8	23	64	4	15	150
DRM-634 A90 P150	DRM-635 A90 P150	3½"	215.9	177.8	19	46.8	23.8	23	64	4	15	150
DRM-634 A1H P150	DRM-635 A1H P150	4"	228.6	190.5	19	46.8	23.8	23	64	4	15	150
DRM-634 A25 P300	DRM-635 A25 P300	1"	123.8	88.9	19	40.5	17.5	23	30	25	90	300
DRM-634 A32 P300	DRM-635 A32 P300	1¼"	133.3	98.4	19	42	19	23	38	15	60	300
DRM-634 A40 P300	DRM-635 A40 P300	1½"	155.6	114.3	22	43.2	20.6	23	38	15	60	300
DRM-634 A50 P300	DRM-635 A50 P300	2"	165.1	127	19	45.2	22.2	23	48	10	40	300
DRM-634 A65 P300	DRM-635 A65 P300	2½"	190.5	149.2	22	48.4	25.4	23	48	10	40	300
DRM-634 A80 P300	DRM-635 A80 P300	3"	209.5	168.3	22	51.6	28.6	23	64	4	15	300
DRM-634 A90 P300	DRM-635 A90 P300	3½"	228.6	184.1	22	53.2	30.2	23	64	4	15	300
DRM-634 A1H P300	DRM-635 A1H P300	4"	254	200	22	54.7	31.7	23	64	4	15	300
DRM-634 A25 P600	DRM-635 A25 P600	1"	123.8	88.9	19	46.9	23.9	23	30	25	90	600
DRM-634 A32 P600	DRM-635 A32 P600	1¼"	133.3	98.4	19	40	27	23	30	15	60	600
DRM-634 A40 P600	DRM-635 A40 P600	1½"	155.6	114.3	22	41.6	28.6	23	38	15	60	600
DRM-634 A50 P600	DRM-635 A50 P600	2"	165.1	127	19	54.8	31.8	23	48	10	40	600
DRM-634 A65 P600	DRM-635 A65 P600	2½"	190.5	149.2	22	58	35	23	48	10	40	600
DRM-634 A80 P600	DRM-635 A80 P600	3"	209.5	168.3	22	61.1	38.1	23	64	4	15	600
DRM-634 A90 P600	DRM-635 A90 P600	3½"	228.6	184.1	25	64.3	41.3	23	64	4	15	600
DRM-634 A1H P600	DRM-635 A1H P600	4"	273	215.9	25	67.5	44.5	23	64	4	15	600
DRM-634 A25 P1K5	DRM-635 A25 P1K5	1"	149.2	101.6	25	58	35	23	30	25	90	1500
DRM-634 A32 P1K5	DRM-635 A32 P1K5	1¼"	158.7	111.1	25	58	35	23	38	15	60	1500
DRM-634 A40 P1K5	DRM-635 A40 P1K5	1½"	177.8	123.8	29	61.1	38.1	23	38	15	60	1500
DRM-634 A50 P1K5	DRM-635 A50 P1K5	2"	215.9	165.1	25	67.5	44.5	23	48	10	40	1500
DRM-634 A65 P1K5	DRM-635 A65 P1K5	2½"	244.5	190.5	29	70.7	47.7	23	48	10	40	1500
DRM-634 A80 P1K5	DRM-635 A80 P1K5	3"	266.7	203.2	32	77	54	23	64	4	15	1500
DRM-634 A1H P1K5	DRM-635 A1H P1K5	4"	311.1	241.3	35	83.4	60.4	23	64	4	15	1500

100 °C	250 °C	max. medium temperature pressure gauge
80 °C	250 °C	max. medium temperature pressure sensor

P1 = mounting of pressure sensors
P2 = mounting of pressure gauge

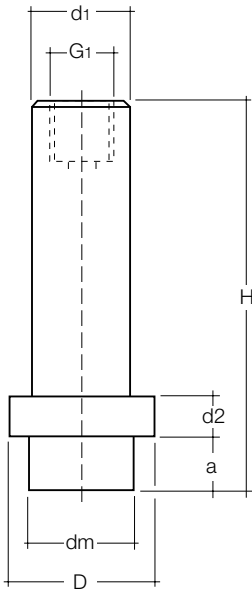

Diaphragm seals DRM-189 for homogenising machines, for direct mounting to pressure gauges

Mounting with block flange or clamping screw (separately available)

Measuring range with sensors: 0 - 60 bar ... 0 - 1600 bar
 Suitable devices: SEN-3x/SEN-8x/SEN-98/MAN-Lx/MAN-Sx
 Measuring range with manometer: 0 - 100 bar ... 0 - 1000 bar
 Suitable devices: MAN-RF2x/MAN-RF7x
 Temperature range: 0 ... +120 °C (calibration temperature +85 °C standard)
 Housing material: stainless steel 1.4571
 Diaphragm: front flush, stainless steel 1.4571
 Max. length of capillary tube: up to 10 m, if required with armour
 Filling liquid: depending on operating conditions
 Connection device: G 1/4 female thread

Model for direct mounting	D	dm	d1	a	d2	H	G1	Suitable for / Type ²⁾
DRM-189F18.0624	24	19	20/21 ¹⁾	6	6	80	G 1/4 IG	MAN (multipart)
DRM-189F23.1235	35	24	20/21 ¹⁾	13	10	90.5	G 1/4 IG	MAN (multipart)
DRM-189F18.0824	23.5	18	G 3/4 M	8	8	113	G 1/4 IG	MAN (multipart)
DRM-189F24.0633	33	24	21.5	6	5.5	52.5	G 1/4 IG	SEN (one-part)
DRM-189F24.1340	40	24	21.5	14	7	78	G 1/4 IG	SEN (one-part)
DRM-189F19.0624	24	19	20.3	6	6	52	G 1/4 IG	SEN (one-part)
DRM-189F19.0623	23.9	19	21.6	6	6	52	G 1/4 IG	SEN (one-part)
DRM-189F24.1235	35	24	22	13	10	61	G 1/4 IG	SEN (one-part)
DRM-189F24.2135	35	24	24	20.5 ³⁾	7.5	80.5	G 1/4 IG	SEN (one-part)
DRM-189F19.0839	39	19	20	8	6.5	125.5	G 1/4 IG	SEN (one-part)
DRM-189F24.2035	35	24	24	20	5.5	81	G 1/4 IG	SEN (one-part)
DRM-189F24.1333	33	24	22	13	6.5	58	G 1/4 IG	SEN (one-part)
DRM-189F24.1335	35	24	22	13	10	91	G 1/4 IG	SEN (one-part)

¹⁾ Depending on the use of clamping screw/ block flange

²⁾ With multi-part construction including integrated throttle/capillary tube for hydraulic dampening in case of strong pressure fluctuations

³⁾ with O-ring groove Ø 18,8x5,5 (5 mm behind membrane)



Information for diaphragm seal

The end unit ready for operation is made up of the pressure gauges and the diaphragm seal and assembling options (Mounting of the diaphragm seal and capillary, filling with filling liquid) and possible special parts.

Diaphragm seals options for assembling together with pressure gauges with bourdon tube or transmitter

Filling liquid		silicone free*				Halocarbon oil	
Assembly design		Glycerin oil		Paraffine oil		Halocarbon oil	
Max. operating temperat. °C		Code	-10...+80	Code	-10...+120	Code	-20...+180
Direct mounting		DF1	✓	DP2	✓	DH3	✓
Direct mounting w. cooling element, multipart		KF1	✓	KP2	✓	KH3	✓
Capillary stainless steel 1.4571	1.0 m	LF1	✓	LP2	✓	LH3	✓
	2.0 m	MF1	✓	MP2	✓	MH3	✓
	Base price: x m	NF1	✓	NP2	✓	NH3	✓
	Add-on price/m						
* For food and finish (according to FDA)							
Filling liquid		Silicone oil					
Assembly design		Silicone oil					
Max. operating temperat. °C		Code	-40...+180	Code	-20...+350	Code	-20...+400
Direct mounting		DS2	✓	DP3	✓	DS4	✓
Direct mounting w. cooling element, multipart		KS2	✓	KP3	✓	KS4	✓
Capillary stainless steel 1.4571	1.0 m	LS2	✓	LP3	✓	LS4	✓
	2.0 m	MS2	✓	MP3	✓	MS4	✓
	Base price: x m	NS2	✓	NP3	✓	NS4	✓
	Add-on price/m						

Accessories for pressure gauges

	Material	Code
Spiral Protection hose (on the capillary)	Stainless steel 1.4301	A
2 x Protection against buckling (on the capillary)	steel	C
Bend 90° with vibration damper	NBR/passivated steel	D
Intermediate piece with vibration damper	NBR/passivated steel	E
Calibration to op. temperature (w/o notice at 20 °C)		
Temperature calibration up to +100 °C		G
Temperature calibration from +100 °C		H
Special calibration (e. g. height adjustment, 2 temperatures)		I
PTFE-coating		K
ECTFE-coating		L
Special materials		S

Information: Over and under ranges of the min./max. pressure ranges are possible, but must be checked depending on each application.

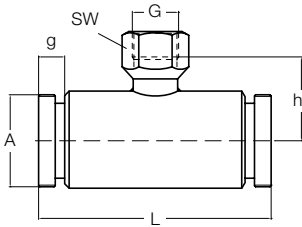

Inline diaphragm seal DRM-500 / 501, sterile connection ISO, for direct mounting and with capillary tube

Measuring range: 1,6 - 40 bar ... 2,5 - 40 bar (depending on the pipe diameter)
 Temperature range: up to 80 °C (> 30 min. to 140 °C)
 Housing: stainless steel 1.4571
 Diaphragm tube: stainless steel 1.4571 (DN 15/20/25/40), stainless steel 1.4404 resp. 1.4435 (DN 50)
 Socket connection: stainless steel 1.4301 (DN 15/20), stainless steel 1.4435 (DN 25/40/50)
 Filling liquid: depending on operating conditions

Model for direct mounting	Model for capillary tube	DN	A	L	h	G	g	SW
DRM-500 D15	DRM-501 D15	15	M30x2	130	26	G¼	12	17
DRM-500 D20	DRM-501 D20	20	M36x2	120	30	G¼	12	17
DRM-500 D25	DRM-501 D25	25	M42x2	120	33	G½	12	27
DRM-500 D40	DRM-501 D40	40	M56x2	110	39	G½	14	27
DRM-500 D50	DRM-501 D50	50	M68x2	100	45	G½	14	27

Model for direct mounting	Model for capillary tube	DN	for tube	O-ring	Weight [kg]	Inner form
DRM-500 D15	DRM-501 D15	15	26.9x2.0	18.5x3.0	0.6	square
DRM-500 D20	DRM-501 D20	20	33.7x2.0	25.0x3.0	0.8	square
DRM-500 D25	DRM-501 D25	25	48.3x2.0	30.0x3.0	0.9	hexagonal
DRM-500 D40	DRM-501 D40	40	60.3x2.0	45.0x3.0	1.3	hexagonal
DRM-500 D50	DRM-501 D50	50	88.9x2.0	55.0x3.0	1.6	hexagonal

DN ½" - 1"

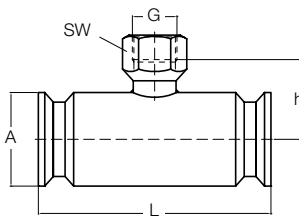

Inline diaphragm seal DRM-502 with clamp connection ISO 2852 for direct mounting

Measuring range: 1,6 - 40 bar ... 2,5 - 40 bar (depending on the pipe diameter)
 Temperature range: up to 80 °C (> 30 min to 140 °C)
 Housing: stainless steel 1.4435
 Diaphragm tube: stainless steel 1.4435 (DN 15/20/25), stainless steel 1.4404 (DN 40/50)
 Socket connection: stainless steel 1.4301 (DN 15/20/25), stainless steel 1.4435 (DN 40/50)
 Filling liquid: depending on operating conditions

DN 1 ½" - 2"

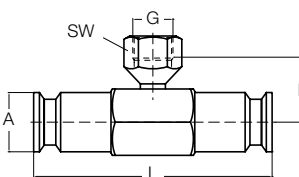

Model for direct mounting	DN	A	L	h	G	SW	Weight [kg]	Inner form
DRM-502 D15	½"	25	140	24	G½	17	0.5	square
DRM-502 D20	¾"	25	120	27	G½	27	0.5	square
DRM-502 D25	1"	50.5	120	36	G½	27	1.6	square
DRM-502 D40	1½"	50.5	120	36	G½	27	1.2	hexagonal
DRM-502 D50	2"	64	100	45	G½	27	1.3	hexagonal

Multipart design

- Very good cooling effect
- Perforated sheet body transmits little heat
- $t_{max} = 450\text{ }^{\circ}\text{C}$
- PN 600 (temperature-dependent)
- All parts are made of 1.4571 stainless steel
- Pressure transmission with a capillary line (\varnothing inner 1.0 mm), that in addition balances out the pulsation of the measured pressure
- Also for direct mounting of diaphragm seals ($t_{max} = 350\text{ }^{\circ}\text{C}$)

One-part design

- Good cooling effect
- Optimum ratio of surface to geometry
- $t_{max} = 300\text{ }^{\circ}\text{C}$
- PN 600 (temperature-dependent)
- Body made of 1.4571 stainless steel
- Pressure transmission with tube diameter (\varnothing inner 3.5 mm), thus no change in reaction time
- Cheaper version
- For use with high viscosity media

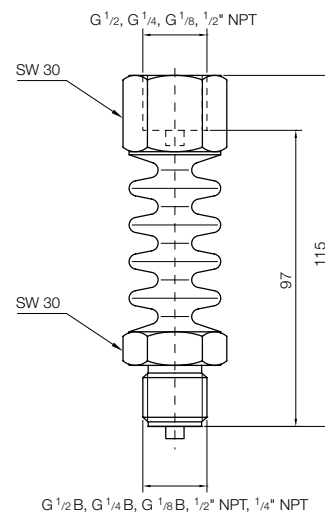
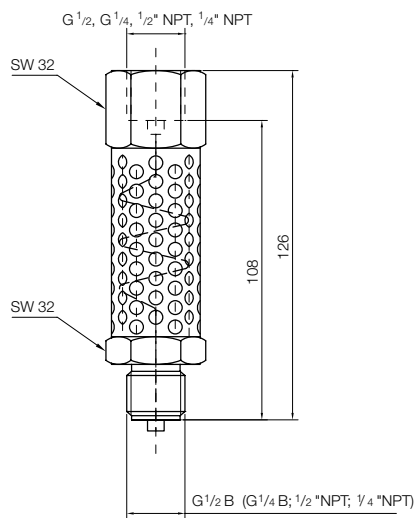

Temperature drift (guide value for cooling effect) and range of use (rated pressure)

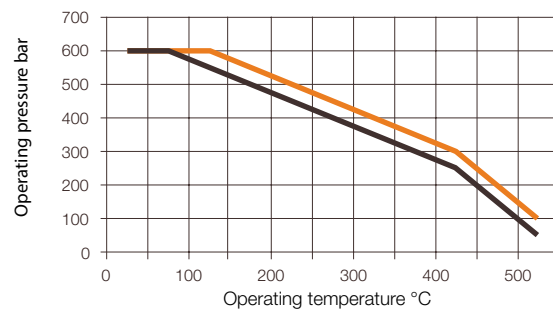
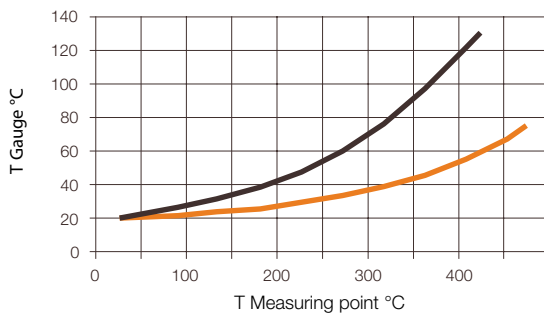

■ MZB-711.7213 to MZB-711.7224 = multipart design
■ MZB-711.7225 and MZB-711.7237 = one-part design



Order Details

Model	Connection measuring device	Process connection
MZB-711.7213	¼" NPT female	G ¼ male
MZB-711.7214	¼" NPT female	G ½ male
MZB-711.7215	¼" NPT female	¼" NPT male
MZB-711.7216	¼" NPT female	½" NPT male
MZB-711.7217	G ¼ female	G ¼ male
MZB-711.7218	G ¼ female	G ½ male
MZB-711.7219	G ¼ female	¼" NPT male
MZB-711.7220	G ¼ female	½" NPT male
MZB-711.7221	G ½ female	G ¼ male
MZB-711.7222	G ½ female	G ½ male
MZB-711.7223	G ½ female	¼" NPT male
MZB-711.7224	G ½ female	½" NPT male
MZB-711.7225	G ½ female	G ½ male

Model	Connection measuring device	Process connection
MZB-711.7226	½" NPT female	½" NPT male
MZB-711.7227	G ½ female	G ¼ male
MZB-711.7228	G ½ female	¼" NPT male
MZB-711.7229	G ½ female	½" NPT male
MZB-711.7230	G ¼ female	G ¼ male
MZB-711.7231	G ¼ female	G ½ male
MZB-711.7232	G ¼ female	¼" NPT male
MZB-711.7233	G ¼ female	½" NPT male
MZB-711.7234	½" NPT female	G ¼ male
MZB-711.7235	½" NPT female	G ½ male
MZB-711.7236	½" NPT female	¼" NPT male
MZB-711.7237	G ⅜" female	G ⅜" female

Other connections upon request.