



Pressure Transmitter



measuring
•
monitoring
•
analysing

PAS

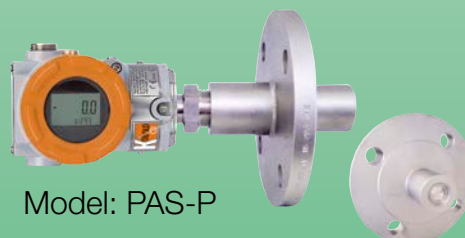

Model: PAS-P



HART
COMMUNICATION FOUNDATION

- Span: -1 ... 1.5 bar up to 0... 600 bar
- t_{\max} : +120 °C
- Process connection: 1/2" NPT, various diaphragm seals on request
- Material: 316L stainless steel, HAST-C, tantalum
- Output: 4 ... 20 mA
- Sensor input: gauge- and absolute pressure
- Self-diagnostic function: sensor, memory A/D converter, power etc.
- Digital communication with HART® protocol
- ATEX-approval

P2

KOBOLD companies worldwide:

AUSTRALIA, AUSTRIA, BELGIUM, BULGARIA, CANADA, CHINA, CZECHIA, FRANCE, GERMANY, GREAT BRITAIN, HUNGARY, INDIA, INDONESIA, ITALY, MALAYSIA, MEXICO, NETHERLANDS, PERU, POLAND, REPUBLIC OF KOREA, RUSSIA, SPAIN, SWITZERLAND, THAILAND, TUNISIA, TURKEY, USA, VIETNAM

KOBOLD Messring GmbH
Nordring 22-24
D-65719 Hofheim/Ts.
Head Office:
+49(0)6192 299-0
+49(0)6192 23398
info.de@kobold.com
www.kobold.com



Description

The Kobold Pressure Transmitter model PAS is a micro processor-based high performance transmitter, which has a flexible pressure calibration and a flexible output signal. It has an automatic compensation of ambient temperature and process variables. A communication with the instrument and a configuration of various parameters is possible via the HART® protocol. All data of sensor is to be input, modified and stored in an EEPROM.

Features

Superior performance

- High reference accuracy:
±0.075 % of calibrated span
(option: ±0.04 % of calibrated span)
- Long-term stability
- High rangeability (100:1)

Flexibility

- Data configuration with HART® configurator
- Measuring of gauge and absolute pressure

Reliability

- Continuous self-diagnostic function
- Automatic ambient temperature compensation
- EEPROM write protection
- Fail-mode process function

Transmitter Description

Electronics module

The Electronics module consists of a circuit board sealed in an enclosure. There are a MCU module, an analogue module, a LCD module and a terminal module in a transmitter.

The MCU module acquires the digital value from the analogue module and applies correction coefficients selected from EEPROM. The output section of the MCU module converts the digital signal to a 4...20 mA output. The MCU module communicates with the HART®-based configurator or control systems such as DCS (Distributed Control System). The Power section of MCU module has a DC-to-DC power conversion circuit and an input/output isolation circuit. The LCD module plugs into the MCU module and displays the digital output in a user-configured unit.

Sensor inputs

The pressure transmitter model PAS is available as a piezo-resistive pressure transmitter which measures gauge pressure as well as absolute pressure. The sensor module converts the resistance into a digital value. The MCU module calculates the process pressure based on this digital value.

Functional Block Diagram

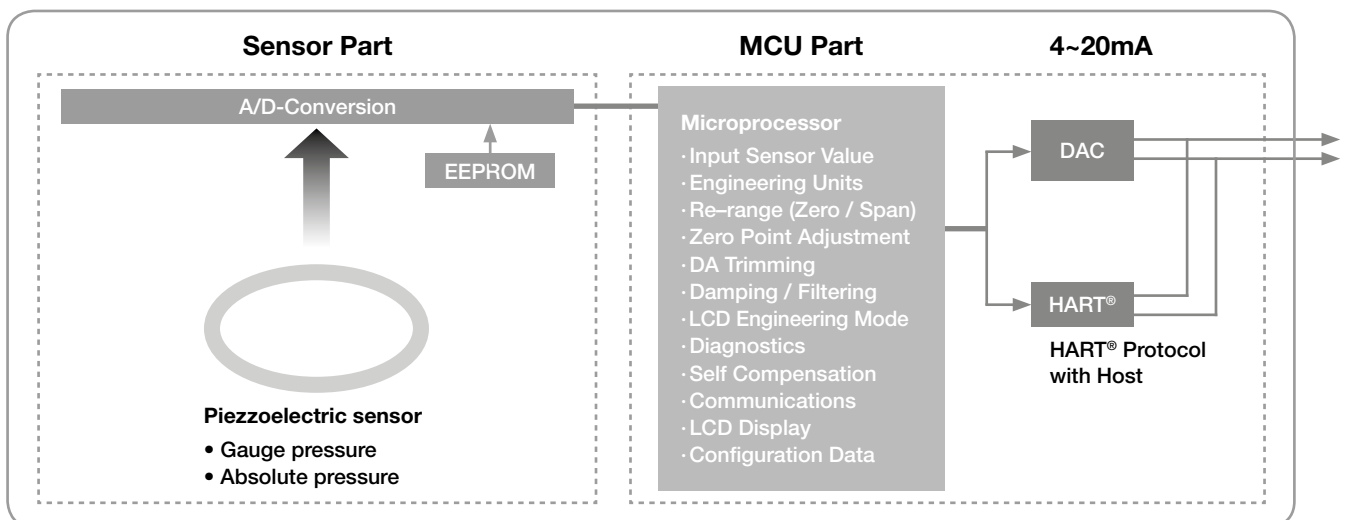



The sensor modules include the following features:

- 0.075 % accuracy
- The software of the transmitter compensates thermal effects, improving performance.
- Precise Input Compensation during operation is achieved with temperature and pressure correction coefficients that are characterized over the range of the transmitter and stored in the sensor module EEPROM memory.
- EEPROM stores sensor information and correction coefficients separately from MCU module, allowing for easy repair, reconfiguration and replacement.

Basic Setups

Following settings can be easily configured from any host that support the HART® protocol:

- Operational parameters
- 4 ... 20 mA (zero points/span)
- Engineering units
- Damping time: 0.25 ... 60 sec.
- Tag: 8 alphanumeric characters
- Descriptor: 16 characters
- Message: 32 characters
- Date: day/month/year

Calibration and trimming

- Lower/upper range (zero/span)
- Sensor zero trimming
- Zero point adjustment
- DAC output trimming
- Transfer function
- Self-compensation

Self-diagnosis and others

- CPU and Analogue Module Fault Detection
- Communication Error
- Fail-mode handling
- LCD indication
- Temperature measurement of sensor module

Process Connection via Diaphragm Seals

For the connection of the pressure transmitter model PAS to all different process connections diverse diaphragm seal versions are necessary. They can be connected to the pressure transmitter by direct mounting or via a capillary tube. Depending on the application different combinations of diaphragm seals, capillary tubes and fill fluids are possible. To clarify those possibilities, the special connections via diaphragm seals are always to be requested separately to the pressure transmitter.

Technical Details

Measuring principle:	piezo-resistive sensor
Measuring span:	-1 ... 1.5 bar up to 0 ... 600 bar (depending on instrument version), zero and span values can be set anywhere within the range limits span must be greater than or equal to the minimum span
Accuracy:	0.075 % of span (0.1 URL ≤ span ≤ URL) ± [0.025 + 0.005 × (URL/span)] % of span (0.01 URL ≤ span < 0.1 URL)
Long-term stability:	± 0.125 % of URL/3 years
Process temperature:	-20 °C ... +120 °C (Approval codes may effect limits. Max. ambient temperature at LCD = +80 °C)
Ambient temperature:	-20 °C ... +60 °C
Ambient temperature effect:	± (0.019 % URL + 0.125 % span) / 28 °C
Storage temperature:	-20 °C ... +85 °C (without condensing)
Humidity limit:	5 % ... 100 % RH
Power supply effect:	± 0.005 % of span/V
Stability:	± [0.125 % URL for 36 months

Pressure limits (with silicone oil)

(Valid for stand-alone unit only without assembled diaphragm seals.)

Model G	-1 ... 3 bar (for range 3) -1 ... 30 bar (for range 4) 0 ... 105 bar (for range 5) 0 ... 400 bar (for range 6) 0 ... 750 bar (for range 7)
Model A	0 ... 5 bar (for range 4) 0 ... 30 bar (for range 5) 0 ... 52 bar (for range 6)

Burst pressure

Model G	6 bar (for range 3) 40 bar (for range 4) 140 bar (for range 5) 500 bar (for range 6) 800 bar (for range 7)
Model A	10 bar (for range 4) 40 bar (for range 5) 70 bar (for range 6)

Wetted materials

Isolating diaphragms:	1.4404 (316L st. st.), Tantalum, HAST-C
Connection thread:	1.4401 (316 st. st.), HAST-C



Technical Details (continued)

Non-wetted materials

Fill fluid:	silicone oil or inert fill
Electronics housing:	aluminum, flameproof (Ex d) and waterproof (IP 67), 316 L st. st. (option)
Cover O-ring:	Buna-N
Paint:	epoxy-polyester or polyurethane
Mounting bracket:	2-inch pipe, 1.4301 (304 st. st.), painted carbon steel with 1.4301 (304 st. st.), U-bolt
Nameplate:	1.4301 (304 stainless steel)
Process connections:	½" NPT female
Mounting position:	upright
Display:	5 Digit LCD
Power supply:	12.5 ... 45 V _{DC} -operation 17.4 ... 45 V _{DC} -HART® communications
Maximum load:	250 Ω at 17.5 V _{DC} 550 Ω at 24 V _{DC} max. loop resistance = $\frac{(U - 12.5 V_{DC})}{0.022 A}$
Electrical connection:	½" NPT conduit with M4 screw terminals G ½ conduit with M4 screw terminals
Output:	two wire 4 ... 20 mA, user-configurable for linear output, digital process value superimposed on 4 ... 20 mA signal, available to any host that conforms to the HART® protocol
Turn-on time:	3 seconds
Protection:	IP 67 for standard (code S)
Weight:	1.7 kg (without additional options) ... 2.83 kg (st. steel housing)
Failure mode:	fail high: current ≥ 21.1 mA fail low: current ≤ 3.78 mA
EMC conformity standards:	EMI (emission) - EN 50081-2:1993 EMS (immunity) - EN 50082-2:1995
ATEX certificate (Option):	Ⓔ II 2G Ex db IIC T6... T4 Gb II 2D Ex tb IIIC T85 °C... T130 °C Db Ⓔ II 1G or 2G Ex ia IIC T5 or T4 Ga or Gb

Technical Details for Version with 50 mm Extended Diaphragm

(Model: PAS-P, special execution for paper and pulp industry)

Application:	level and gauge pressure measurement
Accuracy:	±0.2 % of calibrated span at 20 °C
Long-term stability:	application dependent, typically ±0.125 % of URL/1 year
Process temperature:	+20 °C ... +35 °C
Ambient temperature:	+20 °C ... +35 °C
O-ring:	FPM
Material extended sleeve:	stainless steel 1.4301 (304 st. st.)
Material process connection:	stainless steel 1.4571 / 1.4404 (316 Ti/316L)
Other specifications:	same as standard model



Order Details (Example: **PAS- G EE 3 S 4 N S0 0**)

Model	Version	Material	Measuring range		
			Code	Measuring range	Measuring span
PAS- Pressure transmitter	G = gauge pressure transmitter A = absolute pressure transmitter	EE = 316L st. steel / 316 stainless steel HE ¹⁾ = Hast-C / 316 st. steel TE ¹⁾ = Tantal / 316 st. steel HH ¹⁾ = HAST-C / Hast-C	Diaphragm / others		
			for PAS-G		
			3	-1...+1.5 bar	30 mbar...2.5 bar
			4	-1...+15 bar	170 mbar...16 bar
			5	0...50 bar	500 mbar...50 bar
			6	0...250 bar	2.5 bar...250 bar
			7	0...600 bar	6 bar...600 bar
			for PAS-A		
			4	0...2.5 bar	25 mbar...2.5 bar
			5	0...15 bar	150 mbar...15 bar
6	0...25 bar	250 mbar...25 bar			

Order Details (continued)

Filling liquid	Process connection	Electrical connection	Approvals for hazardous applications	Options
S = silicone	4 = ½" NPT female (standard) X ²⁾ = special	N = ½" NPT epoxy-polyester painted aluminium G = G ½ epoxy-polyester painted aluminium X ²⁾ = special	S0 = standard (waterproof IP67) F0 = ATEX, flameproof enclosure Ex db protection by enclosure Ex tb E0 = ATEX, intrinsically safe, Ex ia	0 = without E = oil free finish M = housing in stainless steel N ³⁾ = mounting of PAS onto diaphragm seal Y ²⁾ = special calibration range

¹⁾ On request

²⁾ Code X not available for ATEX. Order code X and Y must be specified in writing

³⁾ Diaphragm seal model and application data to be specified in clear text. Application Index on the last two pages of this data sheet to be filled out. For summary of diaphragm seal models and possible ranges, see following page 11 onwards. For dimensional details see DRM data sheet.

Order Details Mounting brackets

Description	Order number
Angle type bracket for PAD/PAS Vertical pipe mounting for PAS Vertical pipe mounting for PAD Incl. U-Clamp for 2" pipe mounting bracket and 2 x mounting nuts/ washers Incl. 4 x mounting screws for PAS Incl. 4 x mounting screws for PAD	ZUB-PAD/PAS-K
Flat type bracket for PAD/PAS Horizontal pipe mounting for PAS Vertical pipe mounting for PAD Incl. U-Clamp for 2" pipe mounting bracket and mounting nuts/ washers Incl. 4 x mounting bolts and washers for PAS Incl. 4 x mounting bolts for PAD	ZUB-PAD/PAS-L

Order Details Manifold valve

Description	Order number	Image
2-way manifold valve, direct mount, machined	ZUB-PAS-2BMN	
2-way manifold valve, direct mount, machined	V-2003CDADABAA	

DISCONTINUED MODEL
(shipment as long as stock lasts)



Order Details for Version with 50 mm Extended Diaphragm (Example: **PAS- P ES 3 S A N S 0 0**)

(Model PAS-...P, special execution for paper and pulp industry)

Model	Material	Measuring ranges		
		Code	Measuring range	Measuring span
PAS-P...	...ES... = 316 stainless steel/304, 316L, 316Ti stainless steel	X ¹⁾	special	special
		3	-10 000 mm H ₂ O... +15 000 mm H ₂ O	300 mm H ₂ O... 15 000 mm H ₂ O
		4	-10 000 mm H ₂ O... +150 m H ₂ O	1500 mm H ₂ O... 150 m H ₂ O

Order Details (continued)

Filling liquid	Process connection EN 1092-1/05/B1 or ASME B 16.5	Electrical connection	Approval	Manifold valve	Options
...S... = silicone	A = DN25 PN16 B = DN32 PN16 C = DN40 PN16 D = DN50 PN16 E = DN65 PN16 F = DN80 PN16 G = DN100 PN16 H = DN125 PN16 I = DN150 PN16 N = 1" Class 150 RF P = 1¼" Class 150 RF Q = 1½" Class 150 RF R = 2" Class 150 RF S = 2½" Class 150 RF T = 3" Class 150 RF U = 4" Class 150 RF V = 5" Class 150 RF W = 6" Class 150 RF	N = ½" NPT epoxy-polyester painted aluminium G = G ½ epoxy-polyester painted aluminium X²⁾ = special	S = without, standard (waterproof IP67)	0 = without	0 = without

¹⁾ Please specify in clear text

Dimensions [mm]

Standard model

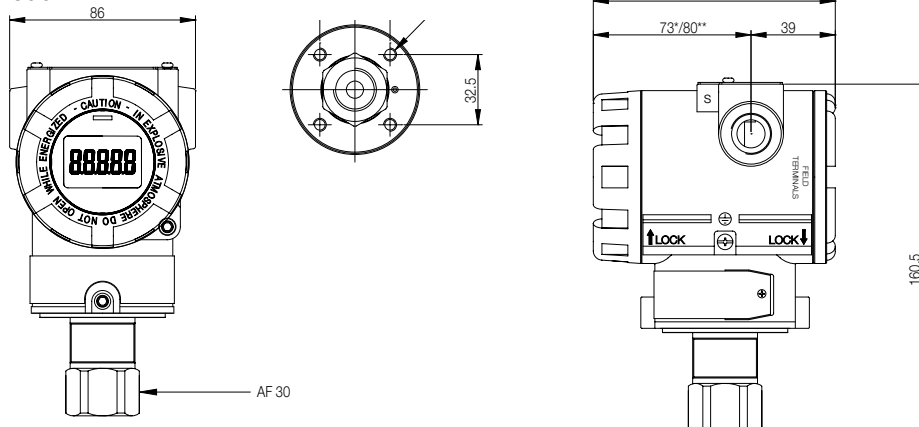

* E xd and standard
 ** Für E xi



Technical Specifications/Dimensions of 2-way Manifold Valves (Direct Mount, Machined)

2-way Manifold valve ZUB-PAS-2BMN

Article number: 2R7A01A0102AA01A0

Technical Details

- Material: AISI 316/L
- Pressure rating: 6000 psi
- Temperature range: see diagram
- Weight: 1.08 kg
- Inlet: 1/2" NPT female
- Outlet: 1/2" NPT male
- Drain: Ø 1/4" NPT female



Included accessories:

- 1 plug
- 1 cap



Temperature range

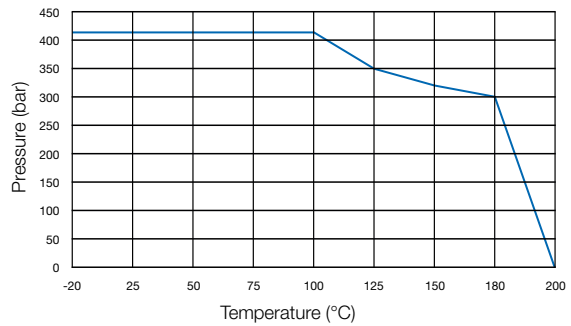

Dimensions [mm]

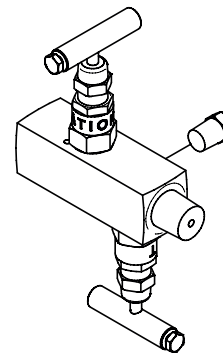
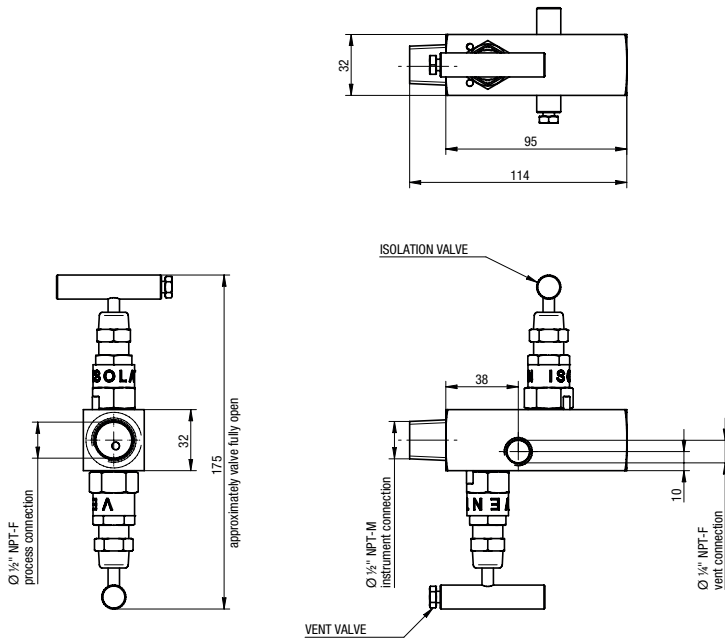

Wiring diagram

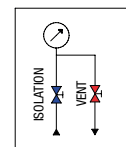

Possible ways of mounting 2-way manifold valve with PAD

Description	Process connection	Illustration
Valve mounted on front side of PAD including oval flange adapter model ZUB-PAD-OVF	1/2" NPT female	



Technical Specifications/Dimensions of 2-way Manifold Valves (Direct Mount, Machined)

Material: AISI 316L
Pressure rating: 6000 psi
Temperature range: -73 °C ... +210 °C (PTFE packing), standard
-54 °C ... +510 °C (GRAPHOIL packing), on request
Weight: 0.88 kg

2-way Manifold valve

(inlet: 1/2" NPT female/outlet: 1/2" NPT male)

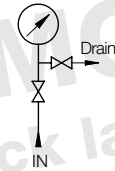
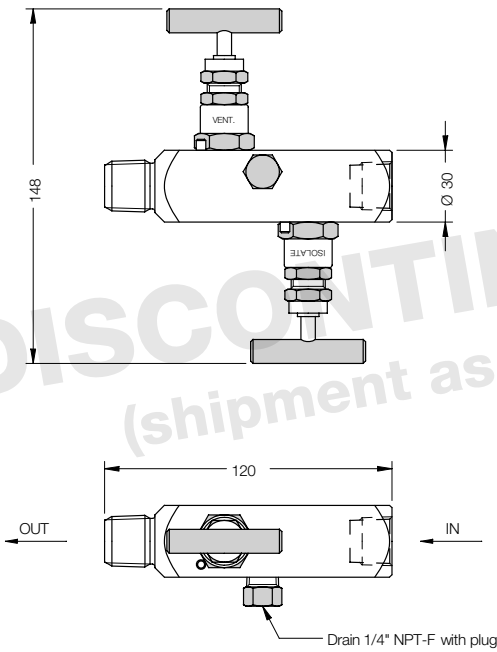

Included Accessories

Plug

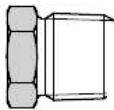

Order Code: V-2003CDADABAA (PTFE packing)

Model: PAS-P with extended diaphragm 50 mm (all dimensions in mm)

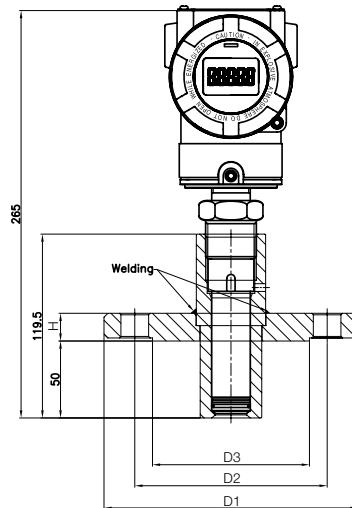

Connection EN 1092-1/05/B1 PN16 (Dimension L is for the factory)

Code	DN	D1	D2	D3	H
A	25	115	85	68	18
B	32	140	100	78	18
C	40	150	110	88	18
D	50	165	125	102	18
E	65	185	145	122	18
F	80	200	160	138	20
G	100	220	180	158	20
H	125	250	210	188	22
I	150	285	240	212	22

Connection ASME B16,5 RF Class 150

Code	inches	D1	D2	D3	H
N	1	108	79.2	50.8	14.2
P	1¼	117.3	88.9	63.5	15.7
Q	1½	127	98.6	73.2	17.5
R	2	152.4	120.7	91.9	19.1
S	2½	177.8	139.7	104.6	22.4
T	3	190.5	152.4	127	23.9
U	4	228.6	190.5	157.2	23.9
V	5	254	215.9	185.7	23.9
W	6	279.4	241.3	215.9	25.4

Example of PAS direct assembled with diaphragm seal
(for dimensional details, see DRM data sheet)

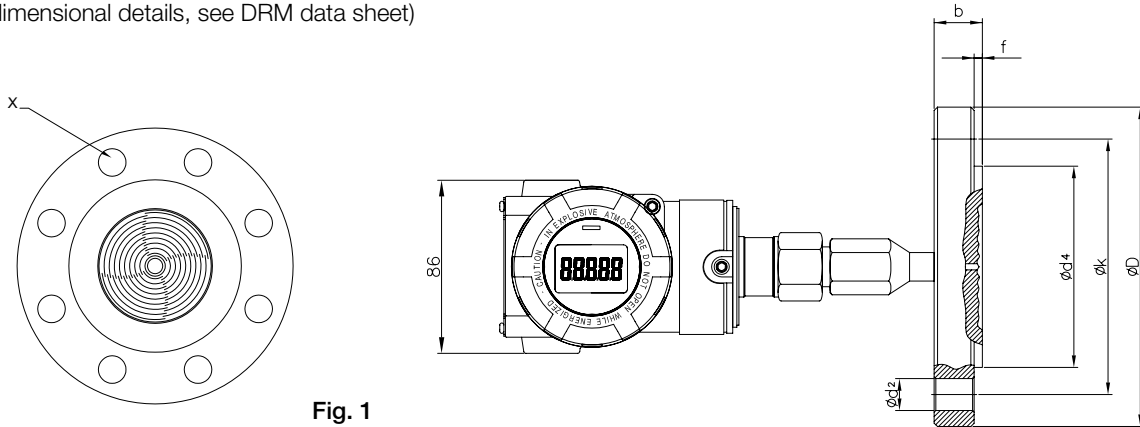

Fig. 1

Example of PAS remote assembled with diaphragm seal and capillary
(for dimensional details, see DRM data sheet)

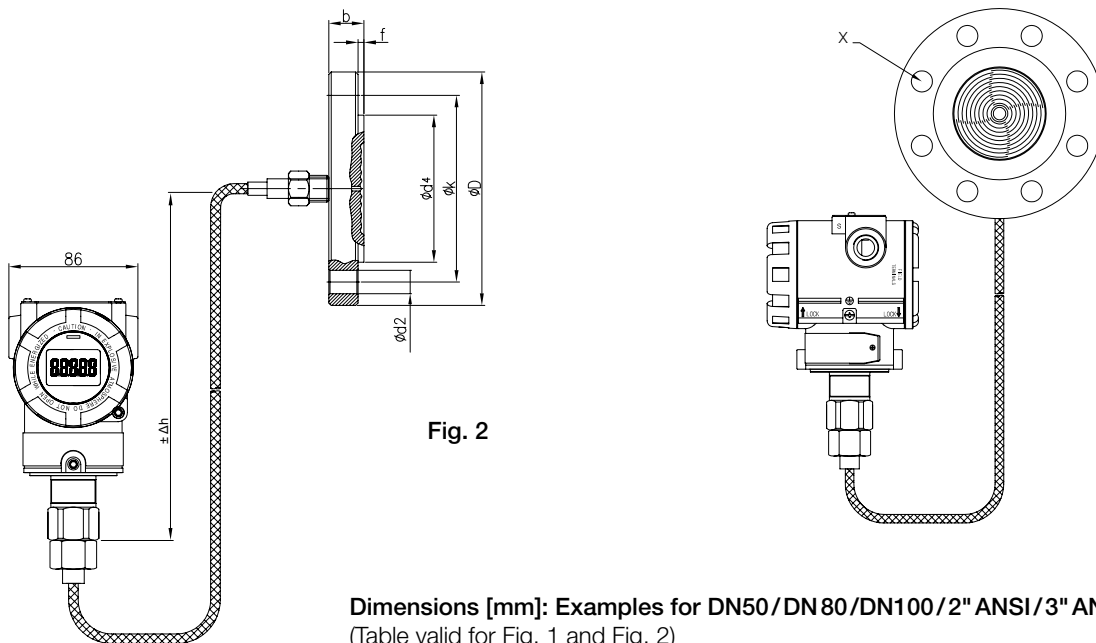

Fig. 2

Dimensions [mm]: Examples for DN50/DN 80/DN100/2" ANSI/3" ANSI/4" ANSI
(Table valid for Fig. 1 and Fig. 2)

Flange type	D	k	d ²	b	f	d ⁴	X
DN50 PN16	165	125	18	18	2	102	4
DN50 PN40	165	125	18	20	2		4
2" ANSI Cl. 150	152.4	120.6	19	19.1	2	92	4
2" ANSI Cl. 300	165.1	127	19	22.3	2		8
DN80 PN16	200	160	18	20	2	138	8
DN80 PN40	200	160	18	24	2		8
3" ANSI Cl. 150	190.5	152.4	19	23.9	1.6	127	4
3" ANSI Cl. 300	209.5	168.3	22	28.4	1.6		8
DN100 PN16	220	180	18	20	2	149	8
DN100 PN40	235	190	22	24	2		8
4" ANSI Cl. 150	228.6	190.5	19	24	1.6	157.2	8
4" ANSI Cl. 300	254	200	22	32	1.6		8

Example of PAS remote assembled with extended diaphragm seal and capillary
 (for dimensional details, see DRM data sheet)

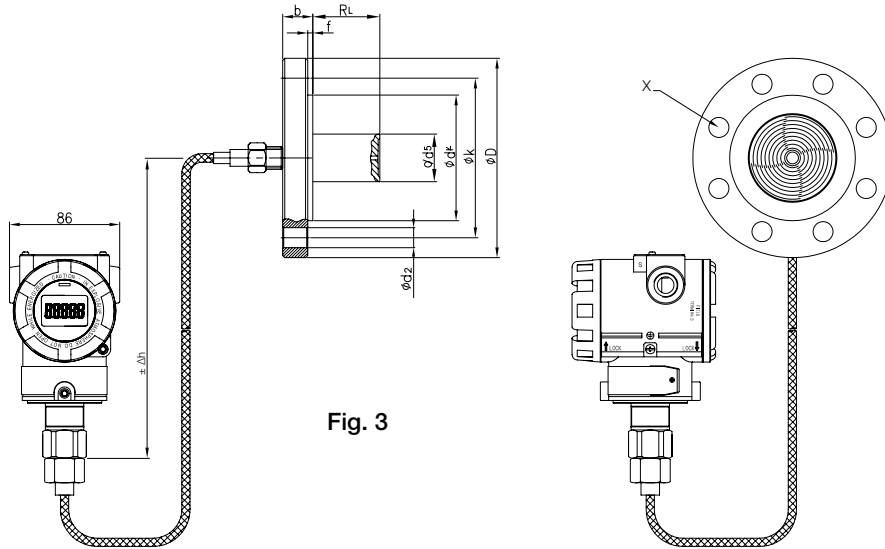

Fig. 3

Dimensions [mm]: Examples for DN50/DN80/DN100/2" ANSI/3" ANSI/4" ANSI

Flange type	D	k	d ²	b	f	d ⁴	X	d ⁵	R _L
DN50 PN16	165	125	18	18	2	102	4	48	50 mm (2")/ 100 mm (4")/ 150 mm (6")/ 200 mm (8")/ (customer specified)
DN50 PN40	165	125	18	20	2		4	48	
2" ANSI Cl. 150	152.4	120.6	19	19.1	2	92	4	48	
2" ANSI Cl. 300	165.1	127	19	22.3	2		8	48	
DN80 PN16	200	160	18	20	2	138	8	76	
DN80 PN40	200	160	18	24	2		8	76	
3" ANSI Cl. 150	190.5	152.4	19	23.9	1.6	127	4	76	
3" ANSI Cl. 300	209.5	168.3	22	28.4	1.6		8	76	
DN100 PN16	220	180	18	20	2	149	8	89	
DN100 PN40	235	190	22	24	2	149	8	89	
4" ANSI Cl. 150	228.6	190.5	19	24	1.6	157.2	8	89	
4" ANSI Cl. 300	254	200	22	32	1.6	157.2	8	89	

Diaphragm seal models (direct or remote assembly)

(Standard device without additional options (e.g. coatings, special materials etc.).

For dimensions/technical data, see DRM data sheet. Accuracy: 0.075% of calibrated span + influence of seal).

Over and under ranges of the min./max. span might be possible, but must be verified by Kobold for each application.

The indicated min./max. spans do not consider any coating of diaphragm seals. For additional information contact Kobold.

Model DRM	Size code	Size	Note	Ø Diaphragm	Max. medium temperature	Min. span [bar]	Max. span [bar]
 DRM-189	F23	Ø 18	for homogenising machines, direct	Ø 18	+120 °C	0...4	1000

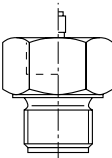

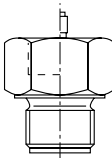

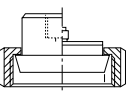
 DRM-600	R15	G ½	fixed male thread, direct	Ø 18	+100 °C	0...4*	1000
	R20	G ¾		Ø 23.8		0...1.6*	1000
	R25	G 1		Ø 29.5		0...1	600
	R32	G 1 ¼		Ø 38		0...0.6	600
	R40	G 1 ½		Ø 40		0...0.6	600
	N15	½" NPT		Ø 18		0...4*	1000
	N20	¾" NPT		Ø 18		0...4*	1000
	N25	1" NPT		Ø 23.8		0...1.6	600
	N32	1 ¼" NPT		Ø 34.5		0...1	600
	M20	M20 x 1,5		Ø 18		0...4	600
	M48	M 48 x 3		Ø 40		0...0.6	600

 DRM-601	R15	G ½	fixed male thread with capillary	Ø 18	+200 °C	0...4*	1000
	R20	G ¾		Ø 23.8		0...1.6*	1000
	R25	G 1		Ø 29.5		0...1	600
	R32	G 1 ¼		Ø 38		0...0.6	600
	R40	G 1 ½		Ø 40		0...0.6	600
	N15	½" NPT		Ø 18		0...4*	1000
	N20	¾" NPT		Ø 18		0...4*	1000
	N25	1" NPT		Ø 23.8		0...1.6	600
	N32	1 ¼" NPT		Ø 34.5		0...1	600
	M20	M20 x 1,5		Ø 18		0...4	600
	M48	M 48 x 3		Ø 40		0...0.6	600



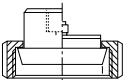
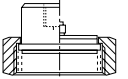
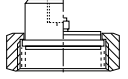
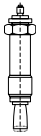
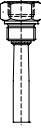

 DRM-602 DIN 11851	R20	DN 20	dairy connection, direct	Ø 18	+100 °C	0...4	40
	R25	DN 25		Ø 23.8		0...1.6	40
	R32	DN 32		Ø 29.5		0...1	40
	R40	DN 40		Ø 38		0...0.6	40
	R50	DN 50		Ø 45.5		0...0.4	25
	R65	DN 65		Ø 64		0...0.25	25
	R80	DN 80		Ø 64		0...0.25	25
	R1H	DN 100		Ø 64		0...0.25	25

* On request only after technical clarification

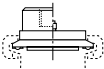
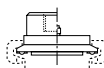

Diaphragm seal models (direct or remote assembly) (continued)

Model DRM	Size code	Size	Note	Ø Diaphragm	Max. medium temperature	Min. span [bar]	Max. span [bar]
DRM-603 DIN 11851 	R20	DN 20	dairy connection, capillary	Ø 18	+200 °C	0...4	40
	R25	DN 25		Ø 23.8		0...1.6	40
	R32	DN 32		Ø 29.5		0...1	40
	R40	DN 40		Ø 38		0...0.6	40
	R50	DN 50		Ø 45.5		0...0.4	25
	R65	DN 65		Ø 64		0...0.25	25
	R80	DN 80		Ø 64		0...0.25	25
R1H	DN 100	Ø 64	0...0.25	25			
DRM-604 IDF 	R25	1"	IDF socket with union nut, direct	Ø 29.5	+100 °C	0...1.6	40
	R40	1 ½"		Ø 42		0...1	40
	R50	2"		Ø 56		0...0.6	40
DRM-605 IDF 	R25	1"	IDF socket with union nut, capillary	Ø 29.5	+200 °C	0...1	40
	R40	1 ½"		Ø 42		0...0.6	40
	R50	2"		Ø 56		0...0.4	40
DRM-606 	R20	G¾	capsule seal with rotatable male, capillary	short capsule	+350 °C	0...6	600
	R28	M28 x 1.5				0...6	600
DRM-607 	R15	G½	capsule seal with fixed male, direct	long capsule	+100 °C	0...1	600
	R20	G¾				0...1	600
DRM-607/1 	R15	G¾	Capsule seal with fixed male, direct	long capsule	+100 °C	0...1	600
	R20	G1				0...1	600
DRM-608/1 	R20	G¾	capsule seal with union nut, capillary	long capsule	+350 °C	0...1	600
	R25	G1	capsule seal with union nut, capillary	long capsule		0...1	600
DRM-610 SMS 	R40	1 ½"	SMS socket with union nut, direct	Ø 34.5	+100 °C	0...1	40
	R50	2"		Ø 45.5		0...0.4	40





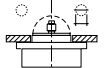

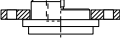
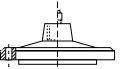
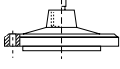
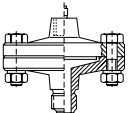
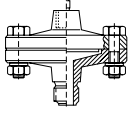

Diaphragm seal models (direct or remote assembly) (continued)

Model DRM	Size code	Size	Note	Ø Diaphragm	Max. medium temperature	Min. span [bar]	Max. span [bar]
DRM-611 SMS 	R40	1 ½"	SMS socket with union nut, capillary	Ø 34.5	+200 °C	0...1	40
	R50	2"		Ø 45.5		0...0.4	40
DRM-612 Clamp 	R25	1"	Tri-Clamp®, direct	Ø 18	+100 °C	0...4	16
	F40	1 ½"		Ø 35.5		0...1	16
	F50	2"		Ø 45.5		0...0.4	16
	R65	2 ½"		Ø 52		0...0.4	16
	R80	3"		Ø 64		0...0.25	10
DRM-613 Clamp 	R25	1"	Tri-Clamp®, capillary	Ø 18	+200 °C	0...4	16
	F40	1 ½"		Ø 35.5		0...1	16
	F50	2"		Ø 45.5		0...0.4	16
	R65	2 ½"		Ø 52		0...0.4	16
	R80	3"		Ø 64		0...0.25	10
DRM-614 APV-RJT 	R20	1"	union-nut, direct	Ø 29.5	+100 °C	0...1.6	100
	R40	1 ½"		Ø 42.5		0...0.6	100
	R50	2"		Ø 56		0...0.4	100
DRM-615 APV-RJT 	R20	1"	union-nut, capillary	Ø 29.5	+200 °C	0...1.6	100
	R40	1 ½"		Ø 42.5		0...0.6	100
	R50	2"		Ø 56		0...0.4	100
DRM-616 	R45	M45 x 2	union-nut, direct	Ø 23.8	+100 °C	0...1.6	1600
DRM-617 	R45	M45 x 2	union-nut, capillary	Ø 23.8	+120 °C	0...1.6	1600

Diaphragm seal models (direct or remote assembly) (continued)

Model DRM	Size code	Size	Note	Ø Diaphragm	Max. medium temperature	Min. span [bar]	Max. span [bar]
 DRM-620	R20	G $\frac{3}{4}$	union-nut, capillary	Ø 23.8	+350 °C	0...1.6	600
	DRM-620/1	R20	G $\frac{3}{4}$	union-nut, capillary	Ø 23.8	+350 °C	0...1.6
 DRM-621	F38	Ø 38 mm	flange, direct	Ø 38	+250 °C	0...0.4	40
 DRM-622	F48	Ø 48 mm	flange, direct	Ø 48	+100 °C	0...0.4	40
	F48 1	Ø 48 mm		Ø 48		0...0.4	40
	F48 2	Ø 48 mm		Ø 48		0...0.4	40
 DRM-622/1	F48	Ø 48 mm	flange, capillary	Ø 48	+200 °C	0...0.4	40
	F48 1	Ø 48 mm		Ø 48		0...0.4	40
	F48 2	Ø 48 mm		Ø 48		0...0.4	40
 DRM-624	F1H	Ø 100 mm	flange, direct	Ø 63.5	+100 °C	0...0.25	40
	F1H T	Ø 100 mm	flange, direct			0...0.25	40
 DRM-624/1	F1H	Ø 100 mm	flange, capillary		+250 °C	0...0.25	40
 DRM-625	R15	G $\frac{1}{2}$	fix male, direct	Ø 63.5	+100 °C	0...0.25	40
	N15	$\frac{1}{2}$ " NPT				0...0.25	40
	I15	G $\frac{1}{2}$ female				0...0.25	40
 DRM-625/1	R15	G $\frac{1}{2}$	fix male, capillary	Ø 63.5	+250 °C	0...0.25	40
	N15	$\frac{1}{2}$ " NPT				0...0.25	40
	I15	G $\frac{1}{2}$ female				0...0.25	40

Diaphragm seal models (direct or remote assembly) (continued)

Model DRM	Size code	Size	Note	Ø Diaphragm	Max. medium temperature	Min. span [bar]	Max. span [bar]
DRM-626 PN25 	R08 A025	G ¼ male	fix male, direct	Ø 56	+80 °C	0...0.4	25
	R08 I025	G ¼ female	fix female, direct	Ø 56		0...0.4	25
	R15 A025	G ½ male	fix male, direct	Ø 56		0...0.4	25
	R15 I025	G ½ female	fix female, direct	Ø 56		0...0.4	25
	N15 A025	½" NPT male	fix male, direct	Ø 56		0...0.4	25
DRM-626 PN100 	R08 A100	G ¼ male	fix male, direct	Ø 56	+80 °C	0...0.4	100
	R08 I100	G ¼ female	fix female, direct	Ø 56		0...0.4	100
	R15 A100	G ½ male	fix male, direct	Ø 56		0...0.4	100
	R15 I100	G ½ female	fix female, direct	Ø 56		0...0.4	100
	N15 A100	½" NPT male	fix male, direct	Ø 56		0...0.4	100
DRM-626 PN250 	R08 A250	G ¼ male	fix male, direct	Ø 56	+80 °C	0...0.4	250
	R08 I250	G ¼ female	fix female, direct	Ø 56		0...0.4	250
	R15 A250	G ½ male	fix male, direct	Ø 56		0...0.4	250
	R15 I250	G ½ female	fix female, direct	Ø 56		0...0.4	250
	N15 A250	½" NPT male	fix male, direct	Ø 56		0...0.4	250
DRM-627 PN25 	R08 A025	G ¼ male	fix male, capillary	Ø 56	+250 °C	0...0.4	25
	R08 I025	G ¼ female	fix female, capillary	Ø 56		0...0.4	25
	R15 A025	G ½ male	fix male, capillary	Ø 56		0...0.4	25
	R15 I025	G ½ female	fix female, capillary	Ø 56		0...0.4	25
	N15 A025	½" NPT male	fix male, capillary	Ø 56		0...0.4	25
DRM-627 PN100 	R08 A100	G ¼ male	fix male, capillary	Ø 56	+250 °C	0...0.4	100
	R08 I100	G ¼ female	fix female, capillary	Ø 56		0...0.4	100
	R15 A100	G ½ male	fix male, capillary	Ø 56		0...0.4	100
	R15 I100	G ½ female	fix female, capillary	Ø 56		0...0.4	100
	N15 A100	½" NPT male	fix male, capillary	Ø 56		0...0.4	100
DRM-627 PN250 	R08 A250	G ¼ male	fix male, capillary	Ø 56	+250 °C	0...0.4	250
	R08 I250	G ¼ female	fix female, capillary	Ø 56		0...0.4	250
	R15 A250	G ½ male	fix male, capillary	Ø 56		0...0.4	250
	R15 I250	G ½ female	fix female, capillary	Ø 56		0...0.4	250
	N15 A250	½" NPT male	fix male, capillary	Ø 56		0...0.4	250
DRM-628 PN06 	F25P06	DN25	flange to EN1092-1, direct	Ø 24	+80 °C	0...1.6	6
	F32P06	DN32		Ø 30		0...1.6	6
	F40P06	DN40		Ø 38		0...0.6	6
	F50P06	DN50		Ø 48		0...0.4	6
	F65P06	DN65		Ø 64		0...0.25	6
	F80P06	DN80		Ø 64		0...0.25	6
	N1HP06	DN100		Ø 64		0...0.25	6
DRM-628 PN16 	F25P16	DN25	flange to EN1092-1, direct	Ø 24	+80 °C	0...1.6	16
	F32P16	DN32		Ø 30		0...1.6	16
	F40P16	DN40		Ø 38		0...0.6	16
	F50P16	DN50		Ø 48		0...0.4	16
	F65P16	DN65		Ø 64		0...0.25	16
	F80P16	DN80		Ø 64		0...0.25	16
	N1HP16	DN100		Ø 64		0...0.25	16
DRM-628 PN40 	F25P40	DN25	flange to EN1092-1, direct	Ø 24	+80 °C	0...1.6	40
	F32P40	DN32		Ø 30		0...1.6	40
	F40P40	DN40		Ø 38		0...0.6	40
	F50P40	DN50		Ø 48		0...0.4	40
	F65P40	DN65		Ø 64		0...0.25	40
	F80P40	DN80		Ø 64		0...0.25	40
	N1HP40	DN100		Ø 64		0...0.25	40

Diaphragm seal models (direct or remote assembly) (continued)

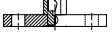
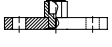
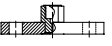
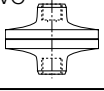
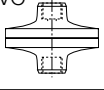
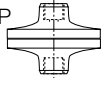
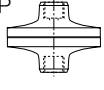
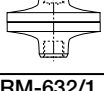
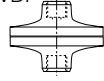
Model DRM	Size code	Size	Note	Ø Diaphragm	Max. medium temperature	Min. span [bar]	Max. span [bar]
DRM-629 PN06 	F25P06	DN25	flange to EN1092-1, capillary	Ø 24	+250 °C	0... 1.6	6
	F32P06	DN32		Ø 30		0... 1.6	6
	F40P06	DN40		Ø 38		0... 0.6	6
	F50P06	DN50		Ø 48		0... 0.4	6
	F65P06	DN65		Ø 64		0... 0.25	6
	F80P06	DN80		Ø 64		0... 0.25	6
	F1HP06	DN100		Ø 64		0... 0.25	6
DRM-629 PN16 	F25P16	DN25	flange to EN1092-1, capillary	Ø 24	+250 °C	0... 1.6	16
	F32P16	DN32		Ø 30		0... 1.6	16
	F40P16	DN40		Ø 38		0... 0.6	16
	F50P16	DN50		Ø 48		0... 0.4	16
	F65P16	DN65		Ø 64		0... 0.25	16
	F80P16	DN80		Ø 64		0... 0.25	16
	F1HP16	DN100		Ø 64		0... 0.25	16
DRM-629 PN40 	F25P40	DN25	flange to EN1092-1, capillary	Ø 24	+250 °C	0... 1.6	40
	F32P40	DN32		Ø 30		0... 1.6	40
	F40P40	DN40		Ø 38		0... 0.6	40
	F50P40	DN50		Ø 48		0... 0.4	40
	F65P40	DN65		Ø 64		0... 0.25	40
	F80P40	DN80		Ø 64		0... 0.25	40
	F1HP40	DN100		Ø 64		0... 0.25	40
DRM 630 PVC 	R08	G ¼ female	fix female, direct	Ø 64	+40 °C	0... 0.25	10
	R15	G ½ female		Ø 64		0... 0.25	10
	N15	½" NPT female		Ø 64		0... 0.25	10
DRM-630/1 PVC 	R08	G ¼ female	fix female, capillary	Ø 64	+40 °C	0... 0.25	10
	R15	G ½ female		Ø 64		0... 0.25	10
	N15	½" NPT female		Ø 64		0... 0.25	10
DRM-631 PP 	R08	G ¼ female	fix female, direct	Ø 64	+40 °C	0... 0.25	10
	R15	G ½ female		Ø 64		0... 0.25	10
	N15	½" NPT female		Ø 64		0... 0.25	10
DRM-631/1 PP 	R08	G ¼ female	fix female, capillary	Ø 64	+40 °C	0... 0.25	10
	R15	G ½ female		Ø 64		0... 0.25	10
	N15	½" NPT female		Ø 64		0... 0.25	10
DRM-632 PVDF 	R08	G ¼ female	fix female, direct	Ø 64	+50 °C	0... 0.25	16
	R15	G ½ female		Ø 64		0... 0.25	16
	N15	½" NPT female		Ø 64		0... 0.25	16
DRM-632/1 PVDF 	R08	G ¼ female	fix female, capillary	Ø 64	+50 °C	0... 0.25	16
	R15	G ½ female		Ø 64		0... 0.25	16
	N15	½" NPT female		Ø 64		0... 0.25	16



Diaphragm seal Models (direct or remote assembly) (continued)

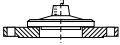
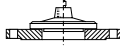

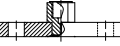
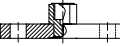
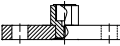

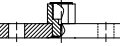
Model DRM	Size code	Size	Note	Ø Diaphragm	Max. medium temperature	Min. span [bar]	Max. span [bar]
 DRM-633	F50	DN50	flange to DIN2527 Form C, direct	Ø 64	+100 °C	0...0.25	40
	F1H	DN 100		Ø 64		0...0.25	40
 DRM-633/1	F50	DN50	flange to DIN2527 Form C, capillary	Ø 64	+250 °C	0...0.25	40
	F1H	DN 100		Ø 64		0...0.25	40

 DRM-634 150 lbs	A25P150	1"	flange to ASME B16.5, direct	Ø 30	+80 °C	0... 1.6	10
	A32P150	1¼"		Ø 38		0...0.6	10
	A40P150	1 ½"		Ø 38		0...0.6	10
	A50P150	2"		Ø 48		0...0.4	10
	A65P150	2 ½"		Ø 48		0...0.4	10
	A80P150	3"		Ø 64		0...0.25	10
	A90P150	3 ½"		Ø 64		0...0.25	10
	A1HP150	4"		Ø 64		0...0.25	10
 DRM-634 300 lbs	A25P300	1"	flange to ASME B16.5, direct	Ø 30	+80 °C	0... 1.6	20
	A32P300	1¼"		Ø 38		0...0.6	20
	A40P300	1 ½"		Ø 38		0...0.6	20
	A50P300	2"		Ø 48		0...0.4	20
	A65P300	2 ½"		Ø 48		0...0.4	20
	A80P300	3"		Ø 64		0...0.25	20
	A90P300	3 ½"		Ø 64		0...0.25	20
	A1HP300	4"		Ø 64		0...0.25	20
 DRM-634 600 lbs	A25P600	1"	flange to ASME B16.5, direct	Ø 30	+80 °C	0... 1.6	40
	A32P600	1¼"		Ø 38		0...0.6	40
	A40P600	1 ½"		Ø 38		0...0.6	40
	A50P600	2"		Ø 48		0...0.4	40
	A65P600	2 ½"		Ø 48		0...0.4	40
	A80P600	3"		Ø 64		0...0.25	40
	A90P600	3 ½"		Ø 64		0...0.25	40
	A1HP600	4"		Ø 64		0...0.25	40
 DRM-634 1500 lbs	A25P1K5	1"	flange to ASME B16.5, direct	Ø 30	+80 °C	0... 1.6	100
	A32P1K5	1¼"		Ø 38		0...0.6	100
	A40P1K5	1 ½"		Ø 38		0...0.6	100
	A50P1K5	2"		Ø 48		0...0.4	100
	A65P1K5	2 ½"		Ø 48		0...0.4	100
	A80P1K5	3"		Ø 64		0...0.25	100
	A90P1K5	3 ½"		Ø 64		0...0.25	100
	A1HP1K5	4"		Ø 64		0...0.25	100

 DRM-635 150 lbs	A25P150	1"	flange to ASME B16.5, capillary	Ø 30	+250 °C	0... 1.6	10
	A32P150	1¼"		Ø 38		0...0.6	10
	A40P150	1 ½"		Ø 38		0...0.6	10
	A50P150	2"		Ø 48		0...0.4	10
	A65P150	2 ½"		Ø 48		0...0.4	10
	A80P150	3"		Ø 64		0...0.25	10
	A90P150	3 ½"		Ø 64		0...0.25	10
	A1HP150	4"		Ø 64		0...0.25	10

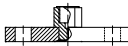

Diaphragm seal models (direct or remote assembly) (continued)

Model DRM	Size code	Size	Note	Ø Diaphragm	Max. medium temperature	Min. span [bar]	Max. span [bar]
DRM-635 300 lbs 	A25P300	1"	flange to ASME B16.5, capillary	Ø 30	+250 °C	0...1.6	20
	A32P300	1 ¼"		Ø 38		0...0.6	20
	A40P300	1 ½"		Ø 38		0...0.6	20
	A50P300	2"		Ø 48		0...0.4	20
	A65P300	2 ½"		Ø 48		0...0.4	20
	A80P300	3"		Ø 64		0...0.25	20
	A90P300	3 ½"		Ø 64		0...0.25	20
	A1HP300	4"		Ø 64		0...0.25	20
DRM-635 600 lbs 	A25P600	1"	flange to ASME B16.5, capillary	Ø 30	+250 °C	0...1.6	40
	A32P600	1 ¼"		Ø 38		0...0.6	40
	A40P600	1 ½"		Ø 38		0...0.6	40
	A50P600	2"		Ø 48		0...0.4	40
	A65P600	2 ½"		Ø 48		0...0.4	40
	A80P600	3"		Ø 64		0...0.25	40
	A90P600	3 ½"		Ø 64		0...0.25	40
	A1HP600	4"		Ø 64		0...0.25	40
DRM-635 1500 lbs 	A25P1K5	1"	flange to ASME B16.5, capillary	Ø 30	+250 °C	0...1.6	100
	A32P1K5	1 ¼"		Ø 38		0...0.6	100
	A40P1K5	1 ½"		Ø 38		0...0.6	100
	A50P1K5	2"		Ø 48		0...0.4	100
	A65P1K5	2 ½"		Ø 48		0...0.4	100
	A80P1K5	3"		Ø 64		0...0.25	100
	A90P1K5	3 ½"		Ø 64		0...0.25	100
	A1HP1K5	4"		Ø 64		0...0.25	100
DRM-637 PN06 	F25P06	DN25	flange to EN1092-1, direct	Ø 24	+80 °C	0...1.6	6
	F32P06	DN32		Ø 30		0...1.6	6
	F40P06	DN40		Ø 38		0...1	6
	F50P06	DN50		Ø 48		0...0.6	6
	F65P06	DN65		Ø 64		0...0.25	6
	F80P06	DN80		Ø 64		0...0.25	6
	N1HP06	DN100		Ø 64		0...0.25	6
DRM-637 PN16 	F25P16	DN25	flange to EN1092-1, direct	Ø 24	+80 °C	0...1.6	16
	F32P16	DN32		Ø 30		0...1.6	16
	F40P16	DN40		Ø 38		0...1	16
	F50P16	DN50		Ø 48		0...0.6	16
	F65P16	DN65		Ø 64		0...0.25	16
	F80P16	DN80		Ø 64		0...0.25	16
	N1HP16	DN100		Ø 64		0...0.25	16
DRM-637 PN40 	F25P40	DN25	flange to EN1092-1, direct	Ø 24	+80 °C	0...1.6	40
	F32P40	DN32		Ø 30		0...1.6	40
	F40P40	DN40		Ø 38		0...1	40
	F50P40	DN50		Ø 48		0...0.6	40
	F65P40	DN65		Ø 64		0...0.25	40
	F80P40	DN80		Ø 64		0...0.25	40
	N1HP40	DN100		Ø 64		0...0.25	40

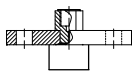
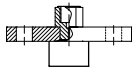
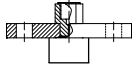
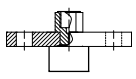
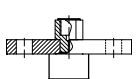
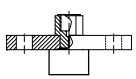

Diaphragm seal models (direct or remote assembly) (continued)

Model DRM	Code	Size	Note	Ø Diaphragm	Max. medium temperature	Min. span [bar]	Max. span [bar]
DRM-638 PN06 	F25P06	DN25	flange to EN1092-1, capillary	Ø 24	+250 °C	0...1.6	6
	F32P06	DN32		Ø 30		0...1.6	6
	F40P06	DN40		Ø 38		0...1	6
	F50P06	DN50		Ø 48		0...0.6	6
	F65P06	DN65		Ø 64		0...0.25	6
	F80P06	DN80		Ø 64		0...0.25	6
	F1HP06	DN100		Ø 64		0...0.25	6
DRM-638 PN16 	F25P16	DN25	flange to EN1092-1, capillary	Ø 24	+250 °C	0...1.6	16
	F32P16	DN32		Ø 30		0...1.6	16
	F40P16	DN40		Ø 38		0...1	16
	F50P16	DN50		Ø 48		0...0.6	16
	F65P16	DN65		Ø 64		0...0.25	16
	F80P16	DN80		Ø 64		0...0.25	16
	F1HP16	DN100		Ø 64		0...0.25	16
DRM-638 PN40 	F25P40	DN25	flange to EN1092-1, capillary	Ø 24	+250 °C	0...1.6	40
	F32P40	DN32		Ø 30		0...1.6	40
	F40P40	DN40		Ø 38		0...1	40
	F50P40	DN50		Ø 48		0...0.6	40
	F65P40	DN65		Ø 64		0...0.25	40
	F80P40	DN80		Ø 64		0...0.25	40
	F1HP40	DN100		Ø 64		0...0.25	40
DRM-639 150 lbs 	A25P150	1"	flange to ASME B16.5, direct	Ø 30	+80 °C	0... 15 psi	145 psi
	A32P150	1¼"		Ø 38		0... 15 psi	145 psi
	A40P150	1½"		Ø 38		0... 15 psi	145 psi
	A50P150	2"		Ø 48		0... 10 psi	145 psi
	A63P150	2½"		Ø 48		0... 10 psi	145 psi
	A75P150	3"		Ø 64		0... 4 psi	145 psi
	A85P150	3½"		Ø 64		0... 4 psi	145 psi
A1HP150	4"	Ø 64	0... 4 psi	145 psi			
DRM-639 300 lbs 	A25P300	1"	flange to ASME B16.5, direct	Ø 30	+80 °C	0... 15 psi	290 psi
	A32P300	1¼"		Ø 38		0... 15 psi	290 psi
	A40P300	1½"		Ø 38		0... 15 psi	290 psi
	A50P300	2"		Ø 48		0... 10 psi	290 psi
	A63P300	2½"		Ø 48		0... 10 psi	290 psi
	A75P300	3"		Ø 64		0... 4 psi	290 psi
	A85P300	3½"		Ø 64		0... 4 psi	290 psi
A1HP300	4"	Ø 64	0... 4 psi	290 psi			
DRM-639 600 lbs 	A25P600	1"	flange to ASME B16.5, direct	Ø 30	+80 °C	0... 15 psi	580 psi
	A32P600	1¼"		Ø 38		0... 15 psi	580 psi
	A40P600	1½"		Ø 38		0... 15 psi	580 psi
	A50P600	2"		Ø 48		0... 10 psi	580 psi
	A63P600	2½"		Ø 48		0... 10 psi	580 psi
	A75P600	3"		Ø 64		0... 4 psi	580 psi
	A85P600	3½"		Ø 64		0... 4 psi	580 psi
A1HP600	4"	Ø 64	0... 4 psi	580 psi			

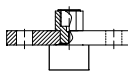
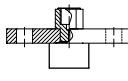
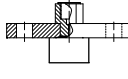
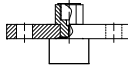
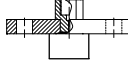

Diaphragm seal models (direct or remote assembly) (continued)

Model DRM	Size code	Size	Note	Ø Diaphragm	Max. medium temperature	Min. span [bar]	Max. span [bar]
DRM-639 1500 lbs 	A25P1K5	1"	flange to ASME B16.5, direct	Ø 30	+80 °C	0... 15 psi	1450 psi
	A32P1K5	1 ¼"		Ø 38		0... 15 psi	1450 psi
	A40P1K5	1 ½"		Ø 38		0... 15 psi	1450 psi
	A50P1K5	2"		Ø 48		0... 10 psi	1450 psi
	A63P1K5	2 ½"		Ø 48		0... 10 psi	1450 psi
	A75P1K5	3"		Ø 64		0... 4 psi	1450 psi
	A1HP1K5	4"		Ø 64		0... 4 psi	1450 psi
DRM-640 150 lbs 	A25P150	1"	flange to ASME B16.5, capillary	Ø 30	+250 °C	0... 15 psi	145 psi
	A32P150	1 ¼"		Ø 38		0... 15 psi	145 psi
	A40P150	1 ½"		Ø 38		0... 15 psi	145 psi
	A50P150	2"		Ø 48		0... 10 psi	145 psi
	A63P150	2 ½"		Ø 48		0... 10 psi	145 psi
	A75P150	3"		Ø 64		0... 4 psi	145 psi
	A85P150	3 ½"		Ø 64		0... 4 psi	145 psi
A1HP150	4"	Ø 64	0... 4 psi	145 psi			
DRM-640 300 lbs 	A25P300	1"	flange to ASME B16.5, capillary	Ø 30	+250 °C	0... 15 psi	290 psi
	A32P300	1 ¼"		Ø 38		0... 15 psi	290 psi
	A40P300	1 ½"		Ø 38		0... 15 psi	290 psi
	A50P300	2"		Ø 48		0... 10 psi	290 psi
	A63P300	2 ½"		Ø 48		0... 10 psi	290 psi
	A75P300	3"		Ø 64		0... 4 psi	290 psi
	A85P300	3 ½"		Ø 64		0... 4 psi	290 psi
A1HP300	4"	Ø 64	0... 4 psi	290 psi			
DRM-640 600 lbs 	A25P600	1"	flange to ASME B16.5, capillary	Ø 30	+250 °C	0... 15 psi	580 psi
	A32P600	1 ¼"		Ø 38		0... 15 psi	580 psi
	A40P600	1 ½"		Ø 38		0... 15 psi	580 psi
	A50P600	2"		Ø 48		0... 10 psi	580 psi
	A63P600	2 ½"		Ø 48		0... 10 psi	580 psi
	A75P600	3"		Ø 64		0... 4 psi	580 psi
	A85P600	3 ½"		Ø 64		0... 4 psi	580 psi
A1HP600	4"	Ø 64	0... 4 psi	580 psi			
DRM-640 1500 lbs 	A25P1K5	1"	flange to ASME B16.5, capillary	Ø 30	+250 °C	0... 15 psi	1450 psi
	A32P1K5	1 ¼"		Ø 38		0... 15 psi	1450 psi
	A40P1K5	1 ½"		Ø 38		0... 15 psi	1450 psi
	A50P1K5	2"		Ø 48		0... 10 psi	1450 psi
	A63P1K5	2 ½"		Ø 48		0... 10 psi	1450 psi
	A75P1K5	3"		Ø 64		0... 4 psi	1450 psi
	A1HP1K5	4"		Ø 64		0... 4 psi	1450 psi

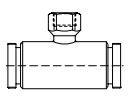
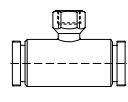
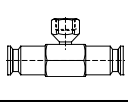
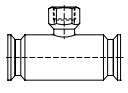

Diaphragm seal models (direct or remote assembly) (continued)

Model DRM	Size code	Size	Note	Ø Diaphragm	Max. medium temperature	Min. span [bar]	Max. span [bar]
DRM 500 ISO Sterile 	D15	DN15	inline, direct	inline	+80 °C	0...1.6	40
	D20	DN20		inline		0...1.6	40
	D25	DN25		inline		0...0.6	40
	D32	DN32		inline		0...0.6	40
	D40	DN40		inline		0...0.4	40
	D50	DN50		inline		0...0.4	40
DRM 501 ISO Sterile 	D15	DN15	inline, capillary	inline	+80 °C	0...1.6	40
	D20	DN20		inline		0...1.6	40
	D25	DN25		inline		0...0.6	40
	D32	DN32		inline		0...0.6	40
	D40	DN40		inline		0...0.4	40
	D50	DN50		inline		0...0.4	40
DRM 502 Clamp ISO 2852 	D15	DN15	inline, direct	inline	+80 °C	0...1.6	40
	D20	DN20		inline		0...1.6	40
	D25	DN25		inline		0...0.6	40
	D32	DN32		inline		0...0.6	40
	D40	DN40		inline		0...0.4	40
	D50	DN50		inline		0...0.4	40
DRM 503 Clamp ISO 2852 	D15	DN15	inline, capillary	inline	+80 °C	0...1.6	40
	D20	DN20		inline		0...1.6	40
	D25	DN25		inline		0...0.6	40
	D32	DN32		inline		0...0.6	40
	D40	DN40		inline		0...0.4	40
	D50	DN50		inline		0...0.4	40

Application Index

Please fill out the following Application Data Sheet while inquiring/ordering model PAS assemble with diaphragm seal model DRM

Order/ Inquiry Ref./ Item No.

Pressure Transmitter (Model, calibration range)	
Diaphragm seal (Model, size code)	
Diaphragm material of DRM (wetted part)	

Medium:	
Operating density	g/cm ²
Operating viscosity	cSt

Temperature:	nominal	minimal	maximal	
Medium temperature				°C/°F
Ambient temperature				°C/°F
Rinsing temperature diaphragm seal				°C/°F
Rinsing temperature capillary				°C/°F



Application Index (continued)

Please fill out the following Application Data Sheet while inquiring/ordering model PAS assemble with diaphragm seal model DRM

Order/ Inquiry Ref./ Item No.

Pressure specification:	Value	
1.1) Operating pressure static	or 1.2	bar/psi
1.2) Operating pressure dynamic min + max	or 1.3	bar/psi
1.3) Operating pressure as frequency in Hz		Hz
2.) Max. negative pressure		
3.) Max. over pressure		
4.1) Display damping: without / light / middle / strong	or 4.2	
4.2) Pressure decrease with time + range		

Arrangement with direct mounting:	
1.) Standard (DRM six o'clock position)	or 2.0
2.) Left (DRM nine o'clock position)	or 3.0
3.) Right (DRM three o'clock position, see Fig. 1)	or 4.0
4.) Special, with description	or 5.0
5.) Position (vertically/horizontally) with pipe diaphragm seal	

Arrangement with capillary:	
1.) Standard (DRM six o'clock position)	or 2.0
2.) on the side (DRM three or 9 o'clock position)	or 3.0
3.) Top (DRM twelve o'clock position)	or 4.0
4.) Special, with description	or 5.0
5.) Position (vertically/horizontally) with pipe diaphragm seal	

Capillary (stainless steel 1.4571/316Ti):	
Length in 'mm'	mm
Protection hose required (Yes/No)	

Height adjustment:	
No	
1.) PAS same level as DRM (diaphragm - pressure transmitter)	or 2.)
Yes	
2.) PAS higher than DRM (specify Δh as in Fig. 2 or Fig. 3)	or 3.) m
3.) PAS lower than DRM (specify Δh as in Fig. 2 or Fig. 3)	m

Options:	
Extended diaphragm seal (Tick mark the desired box)	
No	
Yes	
If Yes, length 'R _L ' of extended diaphragm seal (in mm)	
If Yes, length 'R _L ' of extended diaphragm seal (in inches)	
Filling liquid (Tick mark the desired box)	
Glycerine oil (silicone free, food grade) for operation temp. (-10 ... +80 °C)	
Paraffine oil (silicone free, food grade) for operation temp. (-10 ... +120 °C)	
Silicone oil for operation temp. (-40 ... +200 °C)	
Silicone oil for operation temp. (-20 ... +350 °C)	
Silicone oil for operation temp. (-20 ... +400 °C)	