



Hygienic Installation Systems



measuring
•
monitoring
•
analysing

LZE

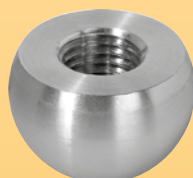

- Hygienic mounting
- Elastomer-free seal system
- p_{\max} : 10 bar; t_{\max} : 250 °C
- Material: stainless steel 1.4404
- Variable mounting with spherical sleeves
- Also suited for small pipe cross-section
- R_a max medium side 0.8 μm
 R_a max external side 1.6 μm



Z

KOBOLD companies worldwide:

ARGENTINA, AUSTRALIA, AUSTRIA, BELGIUM, BULGARIA, CANADA, CHILE, CHINA, COLOMBIA, CZECHIA, EGYPT, FRANCE, GERMANY, GREAT BRITAIN, HUNGARY, INDIA, INDONESIA, ITALY, MALAYSIA, MEXICO, NETHERLANDS, PERU, POLAND, REPUBLIC OF KOREA, ROMANIA, SINGAPORE, SPAIN, SWITZERLAND, TAIWAN, THAILAND, TUNISIA, TURKEY, USA, VIETNAM

KOBOLD Messring GmbH
Nordring 22-24
D-65719 Hofheim/Ts.
Head Office:
+49(0)6192 299-0
+49(0)6192 23398
info.de@kobold.com
www.kobold.com

Description

The mounting system for hygienic measuring points is characterized by a dead space and elastomer-free seal system of the mounting sleeve with the measuring unit. The materials used are safe for use in the food and pharmacy industry.

In order to make it possible to install it in existing pipe systems with common food screw connections, a number of adapters (e.g. Tri-Clamp®, VARIVENT®, conical connection DIN 11851) are available.

The sleeves are equipped with measuring unit connections in three different sizes (M 12x1,5, G ½ and G 1). The measuring unit you have selected determines the necessary size of the weld-in sleeve.

Function

The measuring units for applications in the area of hygiene have a seal cone on the threaded connection, which is pressed against the seal edge of the weld-in sleeve when screwed into the sleeve. The seal edge is deformed slightly and presses against the cone of the measuring unit with the spring force of the metal. This ensures hygienic installation of the measuring units – without elastomer seals.

Welding in prefabricated fittings is much simpler in many cases than the precise and dead space-free attachment of sleeves in pipeline systems. For this reason, KOBOLD offers weld-in fittings (LZE-R) in various pipe diameters and with the matching connections for the Kobold measuring units.

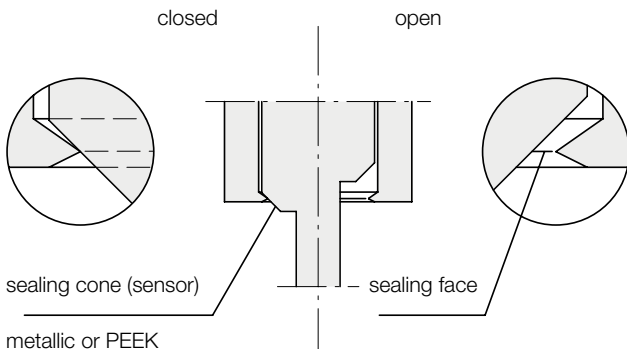
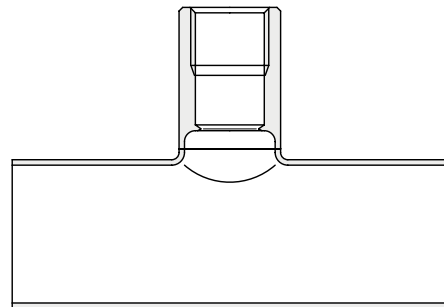

metallic or PEEK
two compression fittings with a PEEK-seal are available for the installation of a temperature sensor at a variable height. The sensor is sealed by means of a conically-shaped seal ring made of highly heat-resistant PEEK. By tightening the clamping screw, the gap between the sensor and sleeve is completely filled on one hand and the seal ring is pressed against the sensor on the other.

Application Areas

- Food industry, e.g. dairies and breweries
- Pharmaceutical industry
- Biotechnology
- Chemical industry
- CIP/SIP-processes

Technical Details

Material:	stainless steel 1.4404, PEEK
Measuring unit connection:	M12x1.5 G ½ G 1
Temperature range	
Seal metal /metal:	-20 ... +250 °C
Seal metal/PEEK:	-20 ... +150 °C
Max. pressure	
Seal metal /metal:	50 bar
Seal metal/PEEK:	10 bar
Surfaces:	hygiene class H3 internal: Ra = 0.8 µm external: Ra = 1.6 µm

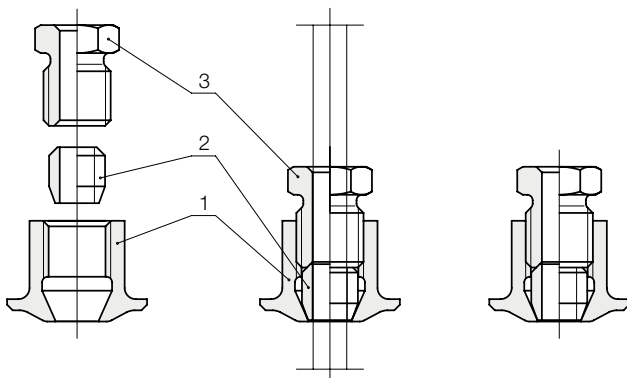

Measuring Unit Connection M12x1,5 for measuring units LNM-__M3... / LTS-__M... / LTS-K-__M...

Model LZE-P1

Cylinder sleeve
with collar

for pipes and flared ends

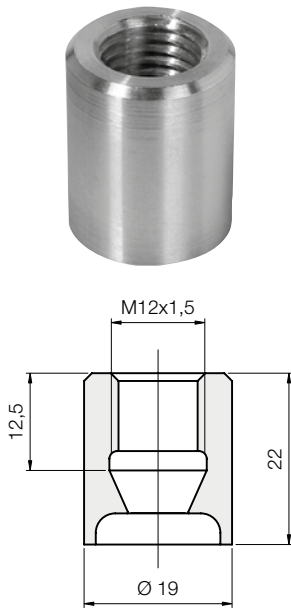

Model LZE-K1

Collar sleeve

for containers

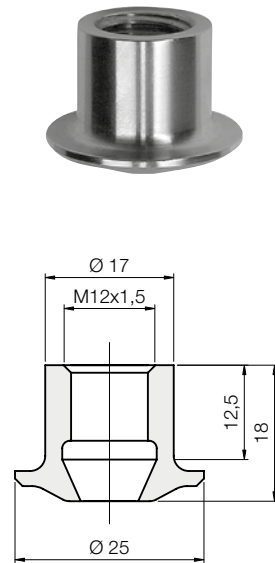

Model LZE-U1

Ball sleeve

for sloping installation

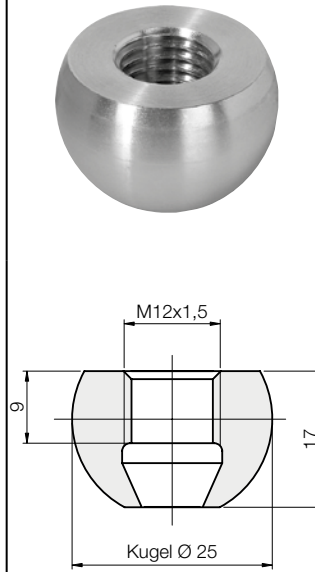

Model LZE-M1

Collar compression
fitting

for temperature sensor
(variable height setting)



Model LZE-S1

Ball compression fitting

for temperature sensor
(variable height setting)

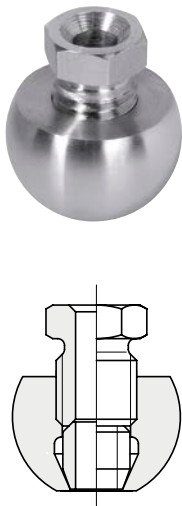

Model LZE-B1

Capped stub

for welding in and closing
off the sleeve

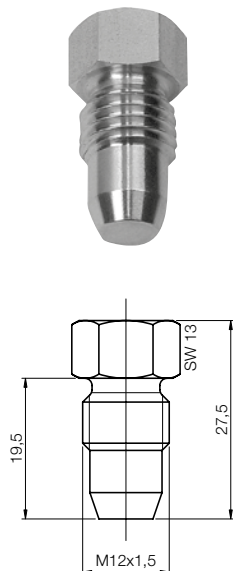

Measuring Unit Connection G 1/2 for meas. units LNM-__G4... / LNZ-... / LNK-K... / LNK-1... / LTS-__T... / LTS-K__T...

Model LZE-Z2
Cylinder sleeve

for containers

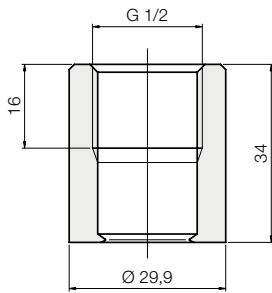

Model LZE-T2
Cylinder sleeve with test hole

for containers, with leak monitoring

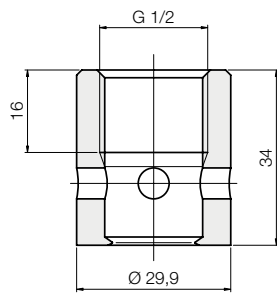

Model LZE-N2
Cylinder sleeve low form

for containers

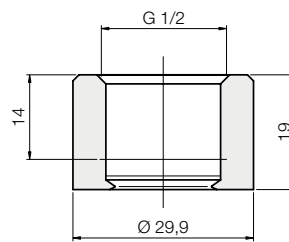

Model LZE-P2
Cylinder sleeve with collar

for pipes and flared ends

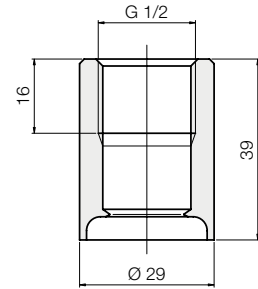

Model LZE-K2
Collar sleeve

for thick-walled containers

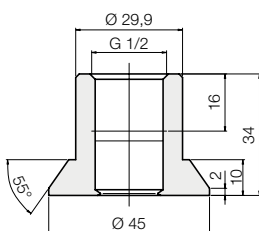

Model LZE-U2
Ball sleeve

for sloping installation

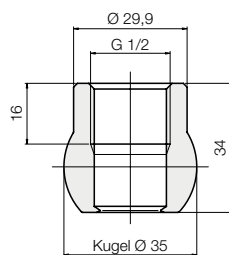

Model LZE-D2
G 1 process adapter

for adaptation to G1 threads

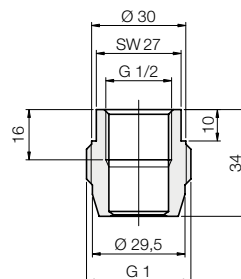

Model LZE-B2
Capped stub

for welding in and closing off the sleeve

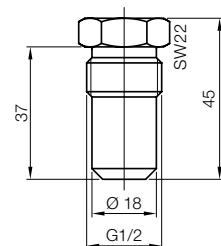

Measuring Unit Connection G 1 for measuring units LNK-2, LNK-3, LNK-4 / LNP

Model LZE-Z3
Cylinder sleeve

for containers

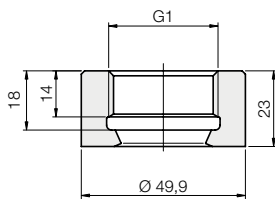

Model LZE-P3
Cylinder sleeve with collar

for pipes and flared ends

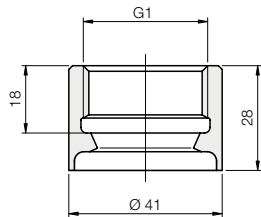

Model LZE-B3
Capped stub

for welding in and closing off the sleeve

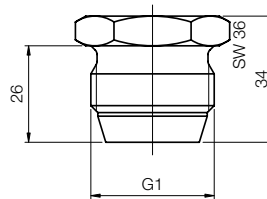

Adapter for Existing Process Connections

Measuring Unit Connection M12 x 1.5 for measuring units LNM-__M3... / LTS-__M... / LTS-K-__M...

Model LZE-L1
Conical connection
DIN 11851
DN 50

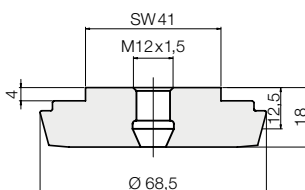

Model LZE-A1
Aseptic lap-joint flange
DIN 11864
DN 65

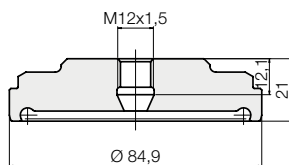

Model LZE-V1
VARIVENT®

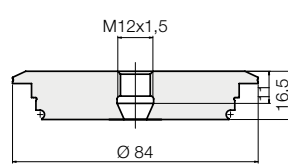

Model LZE-C1
Tri-Clamp®
DN 50

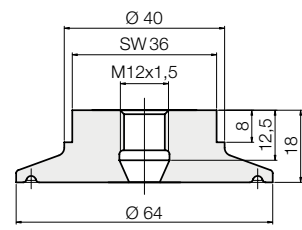

Measuring Unit Connection G 1/2 for meas. units LNM-__G4... / LNZ-... / LNK-K... / LNK-1... / LTS-__T... / LTS-K__T...

Model LZE-L2
Conical connection
DIN 11851
DN 50

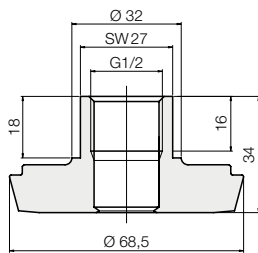

Model LZE-A2
Aseptic lap-joint flange
DIN 11864
DN 65

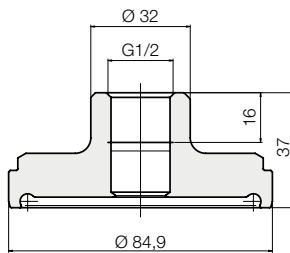

Model LZE-V2
VARIVENT®

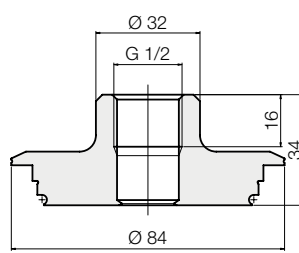

Model LZE-C2
Tri-Clamp®
DN 50

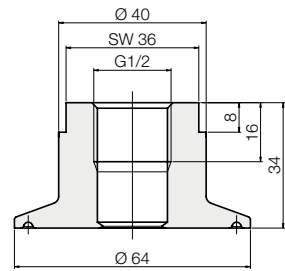

Measuring Unit Connection G 1 for measuring units LNK-2, LNK-3, LNK-4 / LNP

Model LZE-L3
Conical connection
DIN 11851
DN 50

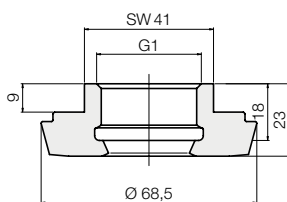

Model LZE-A3
Aseptic lap-joint flange
DIN 11864
DN 65

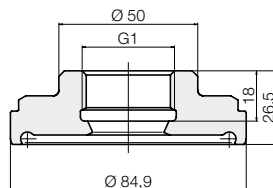

Model LZE-V3
VARIVENT®

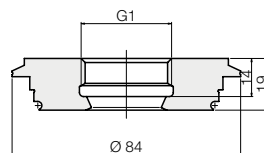

Model LZE-C3
Tri-Clamp®
DN 50

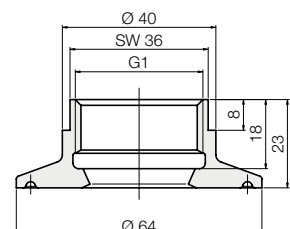

Measuring Unit Connection M12 x 1.5 for measuring units LNM-__M3... / LTS-__M... / LTS-K-__M...

Model LZE-R1

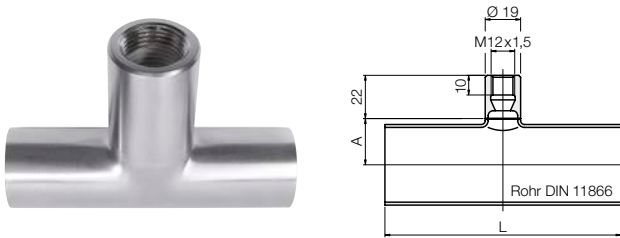

Model	DN	Pipe dimensions	L [mm]	A [mm]
LZE-R1 15	15	19 x 1.5	70	10.5
LZE-R1 25	25	29 x 1.5	100	16.5
LZE-R1 40	40	41 x 1.5	120	23.5
LZE-R1 50	50	53 x 1.5	140	30.5
LZE-R1 65	65	70 x 2.0	160	38.5
LZE-R1 80	80	85 x 2.0	180	47.0

Measuring Unit Connection G 1/2 for measuring units LNM-__G4... / LNZ-... / LNK-K... / LNK-1... / LTS-__T... / LTS-K__T...

Model LZE-R2

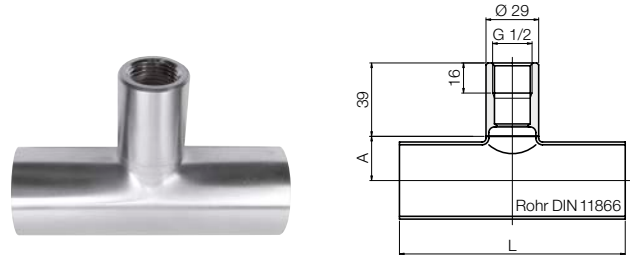

Model	DN	Pipe dimensions	L [mm]	A [mm]
LZE-R2 25	25	29 x 1.5	100	16.5
LZE-R2 40	40	41 x 1.5	120	23
LZE-R2 50	50	53 x 1.5	140	29.5
LZE-R2 65	65	70 x 2.0	160	40
LZE-R2 80	80	85 x 2.0	180	49

Measuring Unit Connection G 1 for measuring units LNK-2. LNK-3. LNK-4 / LNP

Model LZE-R3

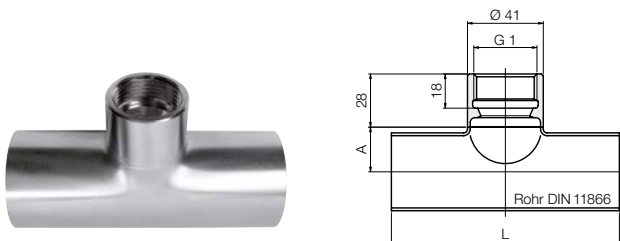

Model	DN	Pipe dimensions	L [mm]	A [mm]
LZE-R3 40	40	41 x 1.5	120	23.5
LZE-R3 50	50	53 x 1.5	140	29.5
LZE-R3 65	65	70 x 2.0	160	39.5
LZE-R3 80	80	85 x 2.0	180	47.5

Capsule for Temperature Probe LTS

Model LZE-H



in preparation



Mounting Sleeves, EHEDG certified

Description	Measuring unit connection		
	M12x1,5	G ½	G 1
Cylinder sleeve		LZE-Z2	LZE-Z3
Cylinder sleeve with test hole		LZE-T2	
Cylinder sleeve low form		LZE-N2	
Cylinder sleeve with collar	LZE-P1	LZE-P2	LZE-P3
Collar sleeve	LZE-K1	LZE-K2	
Ball sleeve	LZE-U1	LZE-U2	
Collar compression fitting	LZE-M1		
Ball compression fitting	LZE-S1		
Adapter:			
Conical connection DIN 11851	LZE-L1	LZE-L2	LZE-L3
Aseptic lap-joint flange DIN 11864	LZE-A1	LZE-A2	LZE-A3
VARIVENT®	LZE-V1	LZE-V2	LZE-V3
Tri-Clamp®	LZE-C1	LZE-C2	LZE-C3
G 1 adapter		LZE-D2	
Capped stub**	LZE-B1	LZE-B2	LZE-B3

*All sleeves must be equipped a capped stub to prevent warping during welding

Weld-in Fittings, EHEDG certified

Model	Description	Measuring unit connection	Pipe nominal width
LZE-R	weld-in fittings	1 = M12x1,5 2 = G ½ 3 = G 1	15 = DN 15 (only with 1 = M12x1,5) 25 = DN 25 (not with 3 = G 1) 40 = DN 40 50 = DN 50 65 = DN 65 80 = DN 80