

Operating Instructions for Flow Meter / Monitor

Model: SMV



1. Contents

1. Contents.....	2
2. Note	3
3. Instrument Inspection.....	4
4. Regulation Use	4
5. Operating Principle.....	5
5.1. SMV	5
5.2. SMV-..21H and SMV-..22H.....	6
6. Mechanical Connection.....	6
7. Electrical Connection	7
7.1. SMV-1... and SMV-3... with Plug Connection	7
7.2. Note for Reed contacts	7
7.3. Example for Contact Protective Measures.....	7
8. Use in hazardous area	8
8.1. Statement an apparatus not containing an own potential ignition source	8
8.2. ATEX contact ...F0... (not for SMV-..21H/..22H)	9
8.3. ATEX reed contact 41R57**	9
9. Operation	16
10. Maintenance	17
11. Technical Information.....	18
12. Order Codes	18
13. Recommended Spare Parts.....	18
14. Dimensions	18
15. Disposal	19
16. EU Declaration of Conformance (SMV)	20
17. UK Declaration of Conformity (SMV).....	21
18. EU Declaration of conformance (Reed contact 41R57**)... ..	22
19. Statement of conformity reed contact 41R57**	23
20. Declaration of the Manufacturer (F0)	26
21. EC-Type Examination Certificate Magnetic reed switch (F0)	27
22. IECEx certificate (F0).....	31

Manufactured and sold by:

Kobold Messring GmbH
Nordring 22-24
D-65719 Hofheim
Tel.: +49(0)6192-2990
Fax: +49(0)6192-23398
E-Mail: info.de@kobold.com
Internet: www.kobold.com

2. Note

Please read these operating instructions before unpacking and putting the unit into operation. Follow the instructions precisely as described herein.

The instruction manuals on our website www.kobold.com are always for currently manufactured version of our products. Due to technical changes, the instruction manuals available online may not always correspond to the product version you have purchased. If you need an instruction manual that corresponds to the purchased product version, you can request it from us free of charge by email (info.de@kobold.com) in PDF format, specifying the relevant invoice number and serial number. If you wish, the operating instructions can also be sent to you by post in paper form against an applicable postage fee.

Operating instructions, data sheet, approvals and further information via the QR code on the device or via www.kobold.com

The devices are only to be used, maintained and serviced by persons familiar with these operating instructions and in accordance with local regulations applying to Health & Safety and prevention of accidents.

When used in machines, the measuring unit SMV should be used only when the machines fulfil the EC-machine guidelines.

as per PED 2014/68/EU

In acc. with Article 4 Paragraph (3), "Sound Engineering Practice", of the PED 2014/68/EU no CE mark.

	Pipe	
	Table 8 Group 1 dangerous fluids	Table 9 Group 2 no dangerous fluids
SMV, 1/4" - 1"	Art. 4, § 3	Art. 4, § 3
SMV, brass, 1 1/4"	not deliverable	Art. 4, § 3
SMV, stainless steel, 1 1/4"	Cat. II	Art. 4, § 3

3. Instrument Inspection

Instruments are inspected before shipping and sent out in perfect condition. Should damage to a device be visible, we recommend a thorough inspection of the delivery packaging. In case of damage, please inform your parcel service / forwarding agent immediately, since they are responsible for damages during transit.

Scope of delivery:

The standard delivery includes:

- Flow Meter / Monitor model: SMV

4. Regulation Use

Series SMV instruments are used for measuring and monitoring liquids. Only clean, low viscosity and homogeneous media may be measured, against which the used materials are resistant. On higher viscous media large measuring errors may occur particularly. Large dirt particles may lead to blocking of the float and therefore large measurement and signal errors. Ferrite particles that stick to the float body (with internal magnet) may also lead to a similar effect. (We recommend a magnet filter).

The instruments are provided as follows:

Flow Measurement

The actual flow may be taken locally from the pointer indication, which is mounted at the side of the housing. The scale shows the flow rate directly in litres per minute of water.

Limit Value Contacts (only model SMV-1.. and SMV-3..)

For the monitoring of the flow rate, the instruments may be fitted with one or two adjustable limit value contacts.

Type of contact:

- N/O contact (standard)
- Changeover contact (standard)
- N/O contact (cCSAus)
- Changeover contact (cCSAus)

The contact is adjustable over the full measuring range by taking the hysteresis into consideration.

5. Operating Principle

5.1. SMV

The KOBOLD Flow Meters and Switches model SMV-... are based on the principle of the well-known float-type flow meters except for the conventional tapering measuring tube.

These patented instruments are provided instead with a cylindrical flow tube with conical slots around the periphery. This eliminates the usual problems of guiding the cylindrical float within a tapering measuring glass. The novel design including the provision of an appropriately dimensioned annular gap of constant width between the float and the flow tube has enabled the sensitivity to dirt to be considerably reduced.

The float comprises permanent magnets actuating a bistable reed contact external to the flow circuit, that is, the flowing medium is hermetically separated from the electrical contact. In addition, it is embedded in a height-adjustable switch housing thus ensuring that the contact cannot be damaged even by an aggressive atmosphere.

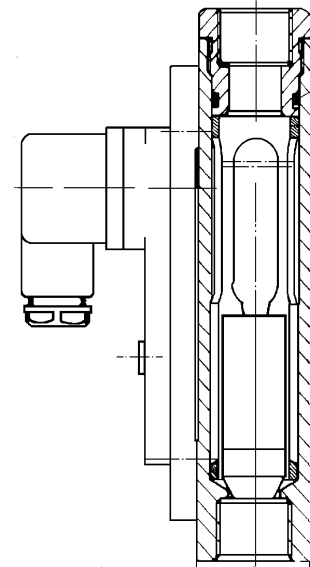

As the medium enters the instrument the float rises. Once its magnetic field reaches the contact tips of the reed switch the contact closes. As the flow increases the float rises further until it reaches its stop. This prevents the float from going beyond the contact range of the magnetic operating tube, that is, the contact remains closed thus ensuring bistable switching.

With the models SMV-2... and SMV-3... the magnetic field also activates an external, that is, hermetically separated indicator, as a result of which flows are measured accurately even at high operating pressures.

The magnetic field and the indicator are designed so as to ensure that the pointer follows even abrupt changes in flow rate.

5.2. SMV-..21H and SMV-..22H

KOBOLD flow meters and -switches series SMV-...21H and SMV-...22H are equipped with a spring-loaded float which is guided within a cylindrical measuring pipe and in opposite to the principals known up to now it is hollow. The medium flows through a circular clearance, which is built by the bore of the float and the mandrel bar (conical shaft) inside.

The float comprises permanent magnets actuating a bistable reed contact external to the flow circuit, that is, the flowing medium is hermetically separated from the electrical contact. In addition, it is embedded in a height-adjustable switch housing thus ensuring that even an aggressive atmosphere cannot damage the contact.

As the medium enters the instrument the float rises. Once the magnetic field reaches the contact tips of the reed switch the contact closes. As the flow increases the float rises further until it reaches its stop. This prevents the float from going beyond the contact range of the magnetic operating tube, that is, the contact remains closed thus ensuring bistable switching.

With the models SMV-2... and SMV-3... the magnetic field also activates an external, that is, hermetically separated indicator, as a result of which flows are measured accurately even at high operating pressures.

The magnetic field and the indicator are designed so as to ensure that the pointer follows even abrupt changes in flow rate.

6. Mechanical Connection

Before installation:

- Make sure that the permitted max. operating pressure and temperature ratings are not exceeded.
- The installation of the unit takes place vertically in the pipe. Flow direction is from bottom to top (according the arrow).
- Remove all the transport safety locks and ensure that no packing material particles remain inside the unit.
- The sealing of connection joints can be realised through Teflon tape or similar material.
- The units may not be installed within the influence of an inductive field.
- If possible, after the mechanical installation, the sealing of connection joints/pipes should be checked.

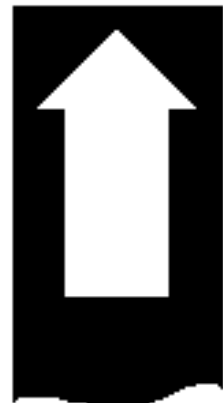

7. Electrical Connection

7.1. SMV-1... and SMV-3... with Plug Connection

- Make sure that the supply wires are de-energized.
- Loosen the holding screw of the plug and pull out the cap from the socket.
- Make connection inside the plug-cap according to the wiring diagram.
- If the contact has not been adjusted yet, it would be appropriate to do so at this point. (see section 9 Operation)
- Push on the plug to the socket, by using the locking screw. (see section 9 Operation).

N/O contact

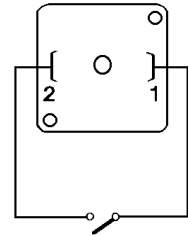

Changeover contact

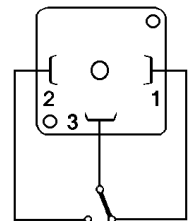

7.2. Note for Reed contacts



Attention! The given electrical specifications of reed switches may never be exceeded, even for a short time. For higher switching capacities we recommend the use of contact protection relays or any other contact protection device.

- After your designated external units are connected to the limit contact and adjustment of desired switching points is accomplished, then all the work regarding connections is finished.
- The unit can now be set in operation.

7.3. Example for Contact Protective Measures

For capacitive and inductive loads (long conductors and relay/protection) we recommend the following protective schemes.

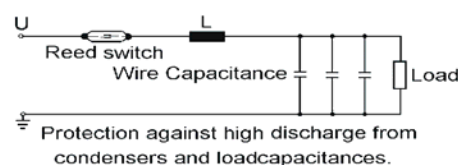
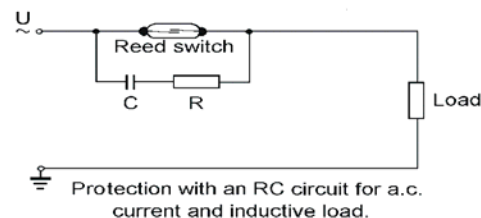
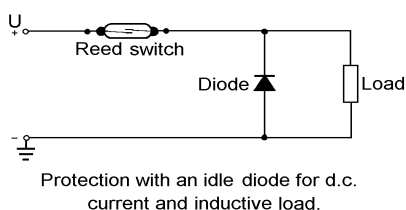
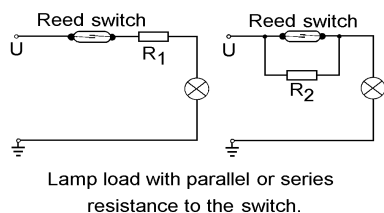

8. Use in hazardous area

8.1. Statement an apparatus not containing an own potential ignition source

Erklärung für Betriebsmittel ohne eigene potentielle Zündquelle in Anlehnung an die Richtlinie 2014/34/EU

TFR 17 HEK_BopZ 0013

Seite/page -1/ 2-

Statement an apparatus not containing an own potential source following Directive 2014/34/EU

Hiermit erklärt die / hereby declares

KOBOLD Messring GmbH, Nordring 22-24, DE 65719 Hofheim

in alleiniger Verantwortung, dass die Ergebnisse, der an den folgenden mechanischem Betriebsmitteln vorgenommenen Prüfungen, die Anforderungen der Richtlinie 2014/34/EU erfüllen.

that the results of the examinations with the mechanical equipment described below comply with the requirements of Directive 2014/34/EU.

Ganzmetall – Durchflussmesser / -wächter SMV, Identifikations-Nummer siehe Lieferunterlagen

sind gemäß Richtlinie 2014/34/EU, Artikel 1

- a) keine Geräte,
- b) keine Schutzsysteme,
- c) keine Sicherheits-, Kontroll- oder Regeleinrichtungen,
- d) keine Komponenten.

Die mechanischen Betriebsmittel haben bei bestimmungsgemäßem Betrieb keine eigene potentielle Zündquelle und bekommen **keine Kennzeichnung** im Sinne der ATEX-Richtlinie. Eine interne Zündgefahrenbewertung wurde durchgeführt. Als Medium wird ein Fluid verwendet.

Variable Area-Flowmeter/switch - All Metal SMV, Identification number see shipping documents

are according to Directive 2014/34/EU, article 1

- a) not an equipment,
- b) not a protective system
- c) not a safety device, controlling device or regulating device
- d) not a component.

When used adequately, this mechanical equipment has no inherent potential ignition source and thus it is **not marked** in accordance with the ATEX- Directive. An internal ignition risk analysis was carried out. The used medium is a fluid.

Die mechanischen Betriebsmittel können, unter Berücksichtigung der geltenden Einrichtungsbestimmungen für Maschinen, Geräte und Anlagen im Ex-Bereich, z.B. EN 1127-1, EN 60079-14 u.a., folgendermaßen eingesetzt werden:

- a) In der Zone 1 (Gas-Ex, Kategorie 2G) in den Explosionsgruppen IIA, IIB und IIC
- b) In der Zone 2 (Gas-Ex, Kategorie 3G) in den Explosionsgruppen IIA, IIB und IIC
- c) In der Zone 21 (Staub-Ex, Kategorie 2D) in den Explosionsgruppen IIIA und IIIB
- d) In der Zone 22 (Staub-Ex, Kategorie 3D) in den Explosionsgruppen IIIA und IIIB

The apparatus can be used as follows in explosive atmospheres in accordance with the applicable erection regulations on machines, devices and plants, such as e.g. EN 1127-1, EN 60079-14, etc.:

- a) In Zone 1 (gas hazard, category 2G) in the explosion groups IIA, IIB and IIC
- b) In Zone 2 (gas hazard, category 3G) in the explosion groups IIA, IIB and IIC
- c) In Zone 21 (dust hazard, category 2D) in the explosion groups IIIA und IIIB
- d) In Zone 22 (dust hazard, category 3D) in the explosion groups IIIA und IIIB

Mögliche elektrische Betriebsmittel sind ohne Einfluss auf den mechanischen Zündschutz. Sie müssen den Anforderungen der jeweils vor Ort herrschenden Zonen genügen und sind nicht Bestandteil dieser Erklärung

Any electrical apparatus that may be used here do not impair the mechanical explosion protection. Those apparatus have to comply with the locally applicable zones and are not subject of this statement.

Folgende harmonisierte Normen/Spezifikationen sind in der am Unterschriftsdatum aktuellen Fassung angewandt worden:

- EN 1127-1 Explosionsfähige Atmosphären, Explosionsschutz, Teil 1: Grundlagen und Methodik

The following harmonised standards and specifications were referred to in their version applicable on the date of signature:

- EN 1127-1 Explosive atmospheres, Explosion prevention and protection, Part 1: Basic concepts and methodology

Wichtige Hinweise:

Please note:

- a) Die vom Hersteller erstellten Einbau und Bedienungsanleitungen sind zwingend zu beachten.
- b) Die im Anwenderland geltenden Errichtungsbestimmungen sind zu beachten.
- c) Die mechanischen Komponenten der SMV-Baureihe sind für Umgebungstemperaturen:
mit PP oder PVDF-Schwabekörper oder NBR-Dichtung
- d) -20 °C .. 60 °C
mit Metall-Schwabekörper und FPM-Dichtung -10 °C .. 90 °C
- e) Bei bestimmungsgemäßem Betrieb wird außen eine Erwärmung < 10 K erwartet; die Temperaturklasse T4 wird eingehalten.

- a) The installation and operating instructions provided by the manufacturer are to be considered compellingly.
- b) The installation regulations valid in the designated country of use are to be observed.
- c) The SMV series with its mechanical components is suitable for ambient temperatures of
with PP or PVDF float or NBR seal -20 °C .. 60 °C
- d) Metal float and FPM seal -10 °C .. 90 °C

- e) At intended operation the temperature rising outside is < 10 K; Temperature class T4 is kept.

Erklärung für Betriebsmittel ohne eigene potentielle Zündquelle in Anlehnung an die Richtlinie 2014/34/EU

TFR 17 HEK_BopZ 0013

Seite/page -2/ 2-

Statement an apparatus not containing an own potential source following Directive 2014/34/EU

- | | |
|--|---|
| <p>f) Sämtliche außen liegenden Werkstoffe bestehen aus geeigneten funkenarmen Materialien, kein Leichtmetall. Der Betreiber ist jedoch für die Überprüfung der Zündgefahr durch Funken beim Betrieb der kompletten Maschine selbst verantwortlich.</p> <p>g) Die mechanischen Komponenten des SMV müssen in den Potentialausgleich einbezogen werden.</p> <p>h) Anschlussleitungen von elektrischen Betriebsmitteln sind geschützt zu verlegen.</p> <p>i) Wenn isolierende Anschlussrohre verwendet werden, dann sind Typen mit einem Durchmesser < 20 mm (IIC) oder < 30 mm (IIA, IIB, Staub) zulässig.</p> <p>j) Staubablagerungen sind regelmäßig zu entfernen.</p> <p>k) Bei Undichtigkeit des Gehäuses darf das Betriebsmittel nicht weiter betrieben werden</p> <p>l) Streuströme (z.B. in Anlagen mit elektrischem Korrosionsschutz) dürfen nicht über die Bauteile geführt werden</p> <p>m) Bei Montagen im Ex-Bereich ist unbedingt die EN 1127-1 Anhang A zu beachten (ggf. funkenarmes Werkzeug benutzen!)</p> | <p>e) All exterior materials consist of suitable low-sparking components no alloy. The operator himself, however, is responsible for checking the risk of ignition caused by sparks during the operation of the complete machine.</p> <p>f) The mechanical components of the SMV have to be integrated in the equipotential bonding.</p> <p>g) Connecting cables of electrical apparatus have to be installed in a protected manner.</p> <p>h) If insulated connection pipes are used, only types with a diameter < 20 mm (IIC) or < 30 mm (IIA, IIB, Dust) may be used.</p> <p>i) Dust deposits are to be removed regularly.</p> <p>j) If the enclosure shows signs of leakage, the apparatus may be not operated further.</p> <p>k) Leakage currents (e.g. in plants with electrical anti-corrosion protection) may not be led over the parts.</p> <p>l) When mounting the apparatus inside an explosive area, Annex A of standard EN 1127-1 has to be adhered to (if necessary, low-sparking tools have to be used).</p> |
|--|---|

Ausgefertigt in Hofheim am 3. Juni 2017

Unterzeichnet für und im Namen der Kobold GmbH

Ort und Datum





Manfred Wenzel Prokurist / authorized signatory

Issued at Hofheim on June 3rd, 2017

Signed for and on behalf of Kobold GmbH



17 HEK_BopZ 0013 Kobold SMV.odt

8.2. ATEX contact ...F0... (not for SMV-...21H/...22H)



-  II 2G Ex mb IIC T6 Gb
 -  II 2 D Ex mb IIC T80 °C Db
- max. 250 V_{AC}/1.5 A/100 VA

8.3. ATEX reed contact 41R57**

ATEX N/O contact 41R57

-  II 3G Ex ic IIC T4 Gc
 -  II 3 D Ex ic IIIC T125 °C Dc
- 20 °C ≤ Ta ≤ 80 °C
max. 250 V_{AC/DC}/1.5 A/100 W/100 VA

ATEX changeover contact 41R57U

-  II 3G Ex ic IIC T4 Gc
 -  II 3 D Ex ic IIIC T125 °C Dc
- 20 °C ≤ Ta ≤ 80 °C
max. 250 V_{AC/DC}/1 A/30 W/60 VA

Ex-relevant excerpt of the operating instructions of the reed contact 41R57 **

1. Preamblel

This excerpt of the operating instructions only represents the ex-relevant aspects. It is copied into the original operating manual in the same or analogous form; Textual changes are permitted, the ex-relevant statements remain.

To ensure the function and for your own safety, please read the enclosed operating instructions carefully before you begin the installation. If you have any questions, please contact the KOBOLD Messring GmbH, Hofheim. It applies with the original operating instructions.

The following standard issues were considered in the evaluation of the product:

- a) IEC 60079-0:2017 Ed. 7 / EN 60079-0:2018 Explosive atmospheres – Part 0: Equipment - General requirements
- b) IEC 60079-11:2011 Ed. 6 + Corr. 2012 / EN 60079-11:2012 Explosive atmospheres - Part 11: Equipment protection by intrinsic safety "i"

2. General information on explosion protection

The reed switches work together with various KOBOLD products and serve there for monitoring. It is available as N/O contact or changeover contact.

The electrical connection is made via a plug - only in intrinsically safe systems.

The reed switch is intended for commercial use and may only be used in accordance with the specifications in the technical documentation of Kobold and the information on the nameplate. It is only operated together with certified products via an intrinsically safe circuit. They comply with the valid standards and regulations.

The installation regulations (e.g. EN 60079-14) for systems in potentially explosive atmospheres must be observed.

Further important details can be found in the corresponding EC-type examination certificate.

Permitted use

- The intrinsically safe reed switch can be used as follows:
 - In Zone 2 (Gas-Ex, EPL Gc) in explosion groups IIA, IIB and IIC
 - In Zone 22 (Dust-Ex, EPL Dc) in explosion groups IIIA, IIIB and IIIC
- The requirements for simple electrical equipment for use in intrinsically safe circuits in zones 1/21 are fulfilled.
- The qualification regarding the surface temperature is T4. For all gases, vapors, mists with an ignition temperature > 135 ° C the equipment is not an ignition source.
 - In the dust Ex area, 125 ° C is the reference temperature for further consideration regarding the safety distance from the smoldering temperature.
- The ambient temperature range is -20 ° C ≤ Ta ≤ 80 ° C.

2.1. Electrical characteristics for Ex i

Electrical data:

- Rated voltage up to 45 volt AC / DC
- Rated current up to 2 A
- $U_{iIC} \leq 30 \text{ V AC / DC}$, $I_{iIC} \leq 250 \text{ mA}$
- $U_{iIB} \leq 45 \text{ V AC / DC}$, $I_{iIB} \leq 2 \text{ A}$
- $U_{iIIC} \leq 45 \text{ V AC / DC}$, $I_{iIIC} \leq 250 \text{ mA}$
- $L_i = \text{negligible}$, $C_i = \text{negligible}$
- Heating on the outer housing $< 15 \text{ K}$

2.2 Type code

The equipment is identified by the following type code:

Type	Description	Item-No.	Remarks
41R57 A B	Type coding		
41R57	Contact device		
A	N/O contact (2 wires), Plug with black cap		
	Change-over contact (3 wires), Plug with grey cap		
B	70 – 75 with marking (not ex-relevant)	202.289	N/O
	45 – 50 with marking	202.285	N/O
	50 – 55 with marking	202.286	N/O
	60 – 65 with marking	202.287	N/O
	70 – 75 with marking	202.288	Change-over
	60 – 65 change-over contact	202.290	Change-over

2.3 Temperature class

The reed switch is suitable for temperature class T4 / T125 ° C.

2.4 General requirements

2.4.1 Intended Use

- a) To ensure safe operation, the products may only be used according to the instructions in the assembly instructions. During use, the legal and safety regulations required for the respective application must be observed in addition. This applies analogously when using accessories.
- b) Failure to comply with the instructions given in this excerpt or in the case of improper handling of the product will render our liability null and void. In addition, the warranty on products and spare parts is void.
- c) The products are not safety elements in terms of their intended use.
- d) Only original parts of the manufacturer may be used.

2.4.2 General safety instructions

The reed switch corresponds to the state of the art and is reliable. The reed switch may pose a residual hazard if improperly used and operated by untrained personnel.

Every person, responsible for the installation, commissioning, maintenance or repair of the reed switch, must have read and understood the assembly instructions and in particular the safety instructions.

- a) Follow the general rules of technology for the selection and proper operation of a product.
- b) All connected electrical and mechanical equipment must be suitable for the respective application.
- c) Observe the notes in these operating instructions as well as the conditions of use and permissible data that appear from the imprints / nameplates of the respective products.
- d) It must be ensured that only product protection types corresponding to the zones are installed!
- e) The product is only approved for proper and intended use in a normal industrial atmosphere. Immersion in liquids is not permitted.
- f) It must be ensured that no falling objects can hit the product.
- g) The operator must ensure the lightning protection for the entire system in accordance with local regulations.
- h) It is the responsibility of the installer to ensure that the function of the reed switch in conjunction with the individual evaluation devices functions properly and is approved for the intended use.
- i) The intrinsically safe connection - including the reed switches - must be made via approved / tested evaluation devices, which may need to be equipped with suitable zener barriers or switching amplifiers.

3. Commissioning, installation

Depending on the IP degree of protection, the time for cleaning the equipment (dust deposits) must be specified. Other important facts:

- a) The product may be put into operation in Zone 2 (Cat. 3G, EPL Gc) or in Zone 22 (Cat. 3D, EPL Dc in intrinsically safe circuits only by specialists with a qualification similar to a qualified person according to TRBS 1203.
- b) The requirements for simple electrical equipment that apply to the hazardous area of Zones 1/21 according to EN 60079-11 are fulfilled.
- c) The products may only be used in the usual industrial atmosphere. In the presence of aggressive substances in the air, the manufacturer must always be consulted. The products must be adequately protected in adverse environmental conditions.
- d) Operation of the product is only permitted in fully assembled and undamaged enclosures. In case of possible damage, a zone carryover may have to be considered by the operator; Moreover, operation of the housing is not permitted if the housing is damaged.
- e) The environmental conditions specified in the operating instructions must be adhered to and protected against adverse environmental conditions.

- f) Heat radiation from foreign products / components must also be considered.
- g) The reed switch must be protected against inadmissible access of liquids and / or soiling.
- h) Fixed parts (e.g. due to frost or corrosion) must not be loosened by force in the presence of an explosive atmosphere. Icing must therefore be avoided.
- i) The reed switch may only be subjected to minor vibrations, see also IEC 34-14.
- j) To ensure the discharge of electrostatic charges, the national requirements must be considered.
- k) In particular, isolated capacities must be prevented.
- l) Only those zener barriers or switching amplifiers may be used whose output circuits are approved / tested for use in potentially explosive atmospheres. In Europe, use in Zones 1/21 requires an EC type-examination certificate for the equipment concerned issued by a body designated for explosion protection.
- m) The voltage of the supply units must be less than or equal to the voltage U_i of the reed switch.
- n) The total current I_o of the supply units must be less than or equal to the current I_i of the reed switch.
- o) For the installation of the intrinsically safe circuit, a control drawing (system description) to be created by the installer / operator is required.
- p) Equipotential bonding must be established along the intrinsically safe circuit when using a grounded supply.
- q) The certificates must be taken into account, including the special conditions specified therein.
- r) Resistant parts of the product (e.g. due to frost or corrosion) must not be forcibly loosened in the presence of an explosive atmosphere.
- s) Within the potentially explosive area, installation may only be carried out taking into account the locally applicable installation regulations. The following conditions must be observed (incomplete):
- t) Installation and maintenance may only be carried out in an explosion-free atmosphere and in compliance with the regulations in force in the country of the operator.
- u) Additional precautions must be taken if the presence of hydrogen sulphide, ethylene oxide and / or carbon monoxide is to be expected: these substances have very low ignition energy!
- v) In the presence of these substances and in the presence of a substance of the explosion group IIC and in the case of presumably existing potentially explosive atmosphere, only spark-free tools may be used!

4. Maintenance, servicing

Definition of terms according to IEC 60079-17:

Maintenance and Repair: A combination of all activities performed to maintain or recover an item in a condition that meets the requirements of the specification in question and ensures the performance of the required functions.

Inspection: An activity involving the careful examination of an object, with the aim of obtaining a reliable statement of the condition of the object, carried out without disassembly or, if necessary, with partial disassembly, supplemented by measures such as measurements becomes.

Visual inspection: A visual inspection is a test that detects visible faults, such as missing screws, without the use of access devices or tools.

Close-up Test: A test that identifies, in addition to the aspects of visual inspection, such errors, such as loose screws, which can only be obtained by using access devices, such as a screwdriver, e.g. steps (if necessary), and tools are visible. For close-up tests, housing usually does not need to be opened or the equipment must be de-energized.

Detail test: A test that detects, in addition to the aspects of close-up testing, such defects as, for example, loose connections that can only be recognized by opening housings and / or, if necessary, using tools and test equipment.

- a) Maintenance measures may only be carried out by qualified persons.
- b) Only use accessories in potentially explosive atmospheres that comply with all requirements of European directives and national legislation.
- c) Maintenance measures with dismantling of the reed switch may only be carried out in an ex-free atmosphere.
- d) The replacement of components may only be carried out with original spare parts, which are also approved for use in potentially explosive areas.
- e) The products must be regularly maintained and cleaned in the Ex area. The intervals are set by the operator according to the environmental demands on site.

	Activity	visual inspection per month	Close inspection every 6 months	detailed inspection every 12 months
1	Visual inspection of the reed switch for damage, remove dust deposits	•		
2	Check for integrity and function			•
3	Testing the entire system	The responsibility of the operator		

5. Troubleshooting

Products operated in conjunction with potentially explosive atmospheres must not be modified. Repairs to the product may only be performed by specially trained and authorized personnel.

6. Disposal

Disposal of the packaging and used parts must be in accordance with the regulations of the country in which the product is installed.

7. Marking of the reed switch (nameplate)

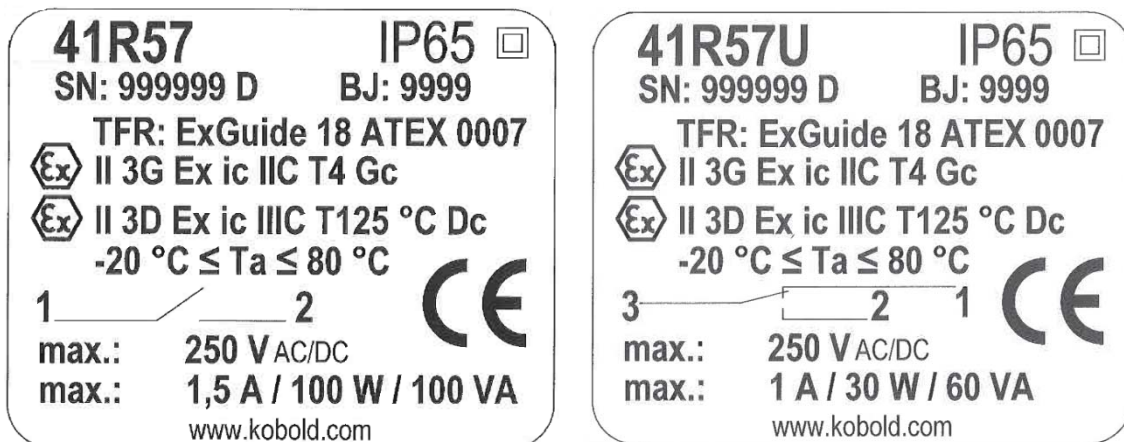

In the serial number the year of manufacture can be coded; optionally, it can also be specified as plain text.

As a rule, a readable marking has been made for the type of explosion protection required in field use - even before the product is put into operation for the first time.

A reed switch that has already been operated in non-intrinsically safe circuits may no longer be used in intrinsically safe circuits later on.

9. Operation

Adjustment of limit switches (model SMV-3., display and contact)

- Loosen both safety screws on contact-socket with a screwdriver.
- Push the switch housing downward.
- Remove the plug from the socket, after loosening the safety screws.
- Connect pin 1 + 2 (changeover contact PIN 2 + 3) with a suitable conductivity circuitry tester.



Attention! Sudden opening of inflow may lead into pressure peaks, which exceeds the operating pressure many times. Water hammer!

- **Case 1: with installed unit**
Open the inlet pipe. Let the medium flow through it slowly, till the pointer display shows the flow volume of desired switching point.
- **Case 2: with non installed unit**
Lift up the float with a suitable tool, till the pointer display shows flow volume of desired switching point

- The reed contact is now closed (electrical conductivity).
- Push the switch housing upward, till the reed contact just opens (no electrical flow). The contact is now set for decreasing flow. If the contact is to be adjusted for the rising flow, the contact must be pushed around hysteresis, i.e. 3-5 mm downwards.
- In this position tighten the safety screws through forced turning. Place the plug cap back. The unit is now ready for operation.
- With right adjustment of limit-switch, bistable operation is achieved, that means on overstepping of adjusted limit value the contact remains closed and with understepping of adjusted limit value, the contact remains open.

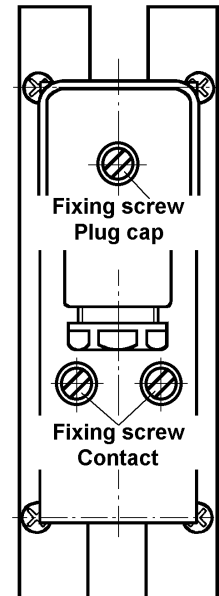

Adjustment of limit value (model SMV-1...)

- Loosen the safety screws on the contact-socket.
- Set the adjustment notch on contact-socket at the desired value on the scale in the housing.
- In this position, tighten the safety screws.

Hysteresis

Hysteresis indicates the difference between switch-on and switch-off points of the contacts. Through factory set coordination of magnet and contact force (AW-number) a float upstroke (hysteresis) of approx. 3-5 mm is achieved. At the same time, it is ensured that the contact operates in a bistable manner.

Overranging



Attention! Pulsating flow should be avoided. Continuous overranging through pulsating flow and subsequently resulting impacts of the float against the float stops may lead to increased wear and tear as well as damage to the unit. In such cases, please consult your supplier.

With continuous flow, the measuring range can be overranged, where only an increase in pressure loss is noticed.

(Permissible max. operational pressure must not be exceeded.)

10. Maintenance

In case, the medium to be measured is uncontaminated, the series SMV are almost maintenance-free. However, at furring or dirt deposits form in the housing or other internal parts, the instruments should be regularly cleaned

With a suitable wrench, remove the instrument from the pipe. After removal of the upper connection, the internal parts may be removed for cleaning.

The internal parts can be cleaned with a suitable brush. After cleaning reassemble the instrument in the correct order of assembly.

We recommend the replacement of O-ring of the connection joints after cleaning.



Attention! Before starting with the maintenance work, please ensure that the electric supply lines are de-energized.

11. Technical Information

Operating instructions, data sheet, approvals and further information via the QR code on the device or via www.kobold.com

12. Order Codes

Operating instructions, data sheet, approvals and further information via the QR code on the device or via www.kobold.com

13. Recommended Spare Parts

Only the parts of the unit and the materials are listed. Depending on the unit model, the parts are available in different sizes. (When ordering, please mention the unit model).

- | | |
|---------------------------------|--|
| 1.1) Float (Brass) | 3.1) O-Ring set NBR |
| 1.2) Float (Polypropylene) | 3.2) O-Ring set FPM |
| 1.3) Float (St. Steel) | 4.1) N/O contact (standard) |
| 1.4) Float (PVDF) | 4.2) Changeover contact (standard) |
| 2.1) Slotted-nozzle (Brass) | 4.3) N/O contact (cCSAus) |
| 2.2) Slotted-nozzle (St. Steel) | 4.4) Changeover contact (cCSAus) |
| | 4.5) N/O contact Ex II 2G EEx m II T6 /
2D IP 67 T 80 °C (not with
connection G 1¼ and 1¼ NPT) |

14. Dimensions

Operating instructions, data sheet, approvals and further information via the QR code on the device or via www.kobold.com

15. Disposal

Note!

- Avoid environmental damage caused by media-contaminated parts
- Dispose of the device and packaging in an environmentally friendly manner
- Comply with applicable national and international disposal regulations and environmental regulations.

Batteries

Batteries containing pollutants are marked with a sign consisting of a crossed-out garbage can and the chemical symbol (Cd, Hg, Li or Pb) of the heavy metal that is decisive for the classification as containing pollutants:

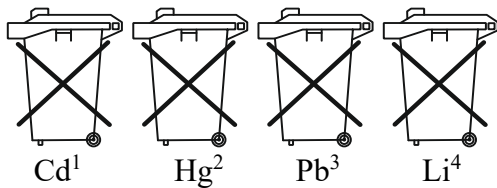

1. „Cd" stands for cadmium
2. „Hg" stands for mercury
3. „Pb" stands for lead
4. „Li" stands for lithium

Electrical and electronic equipment

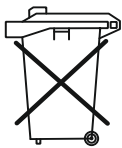

16. EU Declaration of Conformance (SMV)

We, KOBOLD Messring GmbH, Hofheim-Ts, Germany, declare under our sole responsibility that the product:

Flow Meter / Monitor Model: SMV

to which this declaration relates is in conformity with the standards noted below:

EN 61010-1:2011 Safety requirements for electrical equipment for measurement, control and laboratory use - Part 1: General requirements

EN 60529:2014 Degrees of protection provided by enclosures (IP Code)

EN 60079-0:2014 Explosive atmospheres - Part 0: Equipment - General requirements

EN 60079-18:2010 Explosive atmospheres - Part 18: Equipment protection by encapsulation "m"

EN IEC 63000:2018

Technical documentation for the assessment of electrical and electronic products with respect to the restriction of hazardous substances.

Also, the following EC guidelines are fulfilled:

2014/35/EU Low Voltage Directive

for SMV, stainless steel, 1 1/4"

2014/68/EU PED

Category II, Table 8, pipe,
dangerous fluids

Module D1, mark CE0575

Notified body: DNV-AS

Certification number: PEDD000000B

2014/34/EU Equipment and Protective systems intended for
use in a potentially Explosive Atmospheres

Quality Management Production

Certificate number: BVS 21 ATEX ZQS/E110

Notified body: DEKRA Testing and Certification GmbH

Identification number: 0158

2011/65/EU RoHS (category 9)

2015/863/EU Delegated Directive (RoHS III)



H. Volz
General Manager

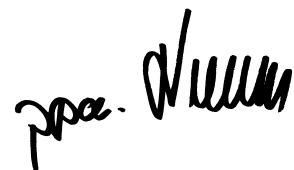

M. Wenzel
Proxy Holder

Hofheim, 16 March 2023

17. UK Declaration of Conformity (SMV)

We, KOBOLD Messring GmbH, Hofheim-Ts, Germany, declare under our sole responsibility that the product:

Flow Monitor Model: SMV

to which this declaration relates is in conformity with the standards noted below:

BS EN 61010-1:2010+A1:2019

Safety requirements for electrical equipment for measurement, control, and laboratory use. General requirements

BS EN 60529:1992+A2:2013

Degrees of protection provided by enclosures (IP Code)

BS EN IEC 63000:2018

Technical documentation for the assessment of electrical and electronic products with respect to the restriction of hazardous substances.

Also, the following UK guidelines are fulfilled:

S.I. 2016/1101

Electrical Equipment (Safety) Regulations 2016

S.I. 2012/3032

The Restriction of the Use of Certain Hazardous Substances in Electrical and Electronic Equipment Regulations 2012

Hofheim, 15 March. 2023



H. Volz
General Manager



M. Wenzel
Proxy Holder

18. EU Declaration of conformance (Reed contact 41R57**)

EU-KONFORMITÄTSERKLÄRUNG zur Bestätigung der Übereinstimmung einer Baugruppe mit der Richtlinie 2014/34/EU

EU DECLARATION OF CONFORMITY to confirm the conformance of a device with the Directive 2014/34/EU

Der Hersteller

The manufacturer

KOBOLD Messring GmbH, Nordring 22-24, DE 65719 Hofheim

erklärt hiermit in alleiniger Verantwortung, dass die nachfolgende Maschine oder Baugruppe

hereby declares under sole responsibility, that the machinery or subassembly equipment described below

Bezeichnung

Description

Reed-Schalter / Reed contact 41R57**

Kennzeichnung / Marking:  II 3G Ex ic IIC T4 Gc or  II 3D Ex ic IIIC T125 °C Dc

Fertigungs-Nummer lt. Lieferpapieren und Typenschild

Serial number see shipping documents and type label

mit den Bestimmungen folgender harmonisierter Normen der Europäischen Union:

conforms with the provisions of the following harmonized standards in the version of the European Union:

- IEC 60079-0:2018 Explosionsgefährdete Bereiche – Teil 0: Betriebsmittel - Allgemeine Anforderungen
- EN 60079-11:2012 Explosionsgefährdete Bereiche – Teil 11: Geräteschutz durch Eigensicherheit "i"

- IEC 60079-0:2018 Explosive atmospheres –Part 0: General Requirements
- EN 60079-11:2012 Explosive atmospheres – Part 11: Equipment protection by intrinsic safety "i"

Ebenfalls mit folgenden Europäischen und nationalen Normen und technischen Vorschriften, in der zum Unterschriftsdatum gültigen Fassung, übereinstimmt:

Also conforms with the following European and National Standards and technical provisions in the version, valid at signature date:

- Technische Regeln für Gefahrstoffe (TRGS) 727:2016, Vermeidung von Zündgefahren infolge elektrostatischer Aufladungen

- Technical rules for hazardous substances TRGS 727:2016, Avoidance of ignition hazards as consequence of electrostatic charging

Ausgefertigt in Hofheim am 19. Januar 2023

done at Hofheim on January, 19th 2023



Name des Unterzeichners

Name of signatory

Manfred Wenzel

Prokrist / *authorized signatory*

Unterschiedet für und im Namen der / Signed for and on behalf of KOBOLD Messring GmbH

Unterschrift / signatur

19. Statement of conformity reed contact 41R57**



STATEMENT OF CONFORMITY

- (1) **STATEMENT OF CONFORMITY**
- (2) Equipment and protective systems intended for use in potentially explosive atmospheres – **directive 2014/34/EU**
- (3) Document No.

ExGuide 18 ATEX 0007 Edition 2

- (4) Equipment: **Reed contact type 41R57****
- (5) Manufacturer: **KOBOLD Messring GmbH**
- (6) Address: **Nordring 22-24
65719 Hofheim, Germany**
- (7) The design of this product and the various permissible versions are specified in the annex to this certificate and the documents listed therein.
- (8) ExGuide Technology - Geoffrey Stenzel, as a certified engineering company, certifies that the product meets the basic safety and health requirements for the design and construction of category 3 equipment for use in potentially explosive atmospheres in accordance with Annex II of Directive 2014/34/EU. The results of the test are documented in the confidential test report No. P20220024PB01.
- The QM system of the engineering offices ExGuide Technology - Geoffrey Stenzel is monitored according to ISO 9001:2015 by AJA Europe Ltd. and listed under certificate No. AJ AEU/19/15703.
- (9) The essential health and safety requirements are met by compliance with:
- EN IEC 60079-0: 2018 EN 60079-11:2012**
- (10) If the sign "X" is placed after a certificate number, special conditions for the safe use of the equipment are indicated in the appendix to this certificate. If no certificate number according to (3) is applied to the device, the sign "X" must be placed after the Ex marking according to (12).
- (11) This statement of conformity refers only to the design and specifications for the construction of the device according to directive 2014/34/EU. Further requirements apply to the manufacture and placing into market of this product. These requirements are not covered by this certificate.
- (12) The Ex-marking of the product must contain the following information:

 **II 3G Ex ic IIC T4 Gc**
II 3D Ex ic IIIC T125°C Dc

ExGuide Technology – Geoffrey Stenzel
Katernberger Str. 107
45327 Essen, Germany

Essen, dated 18 January 2023

Dipl.-Ing. Geoffrey Stenzel

Page 1 of 3

This declaration of conformity has no validity without signature and stamp and may only be distributed unchanged. Excerpts and changes require the approval of ExGuide Technology - Geoffrey Stenzel, Katernberger Str. 107, 45327 Essen, Germany
Tel. +49 (0) 522910-93, Fax. +49 (0) 522910-99





(13) Annex

(14) **ExGuide 18 ATEX 0007** Edition 2

(15) Description of the product

15.1 Subject and type designation

Reed contact type 41R57**

Explanation of the type designation

41R57 **Reed contact**

1. Asterisk **Contact type**

3 = N/O contact (2 wires), Plug with black cap

6 = Change-over contact (3 wires), plug with grey cap

2. Asterisk Not Ex relevant

15.2 Description

The reed contact work with different devices and serve there values for monitoring. They are available as N/O or change-over contacts. Standard electrical connection is made through a permanently connected cable inside between the reed contact and the pins of the plug.

Changes

Application of harmonized standard EN IEC 60079-0:2018.

15.3 Technical data

15.3.1 Thermal data

Ambient temperature range	T_a	-20 °C to +80 °C
Heating at the outer enclosure	ΔT	<15 K

15.3.2 Electrical data

Maximum input voltage	U_i	30 V AC/DC for IIC 45 V AC/DC for IIB and IIIC
Maximum input current	I_i	250 mA for IIB and IIIC 2 A for IIB
Effective internal inductance	L_i	negligible
Effective internal capacitance	C_i	negligible

Page 2 of 3

This declaration of conformity has no validity without signature and stamp and may only be distributed unchanged. Excerpts and changes require the approval of ExGuide Technology - Geoffrey Stenzel, Katernberger Str. 107, 45327 Essen, Germany
Tel. +49 (0) 522910-93, Fax. + 49 (0) 522910-99





15.4 Minimum marking requirements on this equipment

Manufacturer's name and postal address	KOBOLD Messring GmbH Nordring 22-24 65719 Hofheim, Germany
Type designation	41R57**
Serial No.	
Year of manufacturer	
Ex symbol	
Ex marking	II 3G Ex ic IIC T4 Gc II 3D Ex ic IIIC T125 °C Dc
CE marking	
Ambient temperature range	-20 °C ≤ T _a ≤ +80 °C

(16) Test and assessment report No. P20220024PB01, dated 18 January 2023

(17) Special conditions for safe use

None

(18) Essential health and safety requirements

Fulfilled by compliance with the above-mentioned standards.

ExGuide Technology – Geoffrey Stenzel
Katernberger Str. 107
45327 Essen, Germany

Essen, dated 18 January 2023

Dipl.-Ing. Geoffrey Stenzel

Page 3 of 3

This declaration of conformity has no validity without signature and stamp and may only be distributed unchanged. Excerpts and changes require the approval of ExGuide Technology - Geoffrey Stenzel, Katernberger Str. 107, 45327 Essen, Germany
Tel. +49 (0) 522910-93, Fax. +49 (0) 522910-99



20. Declaration of the Manufacturer (F0)

.steute

EU-KONFORMITÄTSERKLÄRUNG EU DECLARATION OF CONFORMITY

gemäß der Explosionsschutz-Richtlinie 2014/34/EU
according to Explosion Protection Directive 2014/34/EU

Als Hersteller trägt die Firma steute Technologies die alleinige Verantwortung für die Ausstellung dieser Konformitätserklärung /
As manufacturer, steute Technologies is solely responsible for issuing this Declaration of Conformity.

Art und Bezeichnung der Betriebsmittel /
Type and name of equipment: Ex Magnetsensor, Typen Ex RC ...
Ex magnetic sensor, types Ex RC ...

Hiermit erklären wir, dass die oben aufgeführten elektrischen Betriebsmittel aufgrund der Konzipierung und Bauart den grundlegenden Sicherheits- und Gesundheitsanforderungen nach Anhang II der Richtlinie 2014/34/EU entsprechen. /
We hereby declare that, due to its design and construction, the above mentioned electrical equipment satisfies the requirements of directive 2014/34/EU in respect to basic safety and health requirements according to Annex II.

Angewandte EU-Richtlinie / Applied EU directive	Harmonisierte Normen / Harmonised standards	Neueste harmonisierte Normen / Latest harmonised standards
2014/34/EU Explosionsschutzrichtlinie / 2014/34/EU Explosion Protection Directive	EN IEC 60079-0:2018, EN 60079-18:2015 + A1:2017	
EG-Baumusterprüfung / EU-type examination:	Ex-Kennzeichnung / Ex marking	Neueste Ex-Kennzeichnung / Latest Ex marking
DMT 01 ATEX E 058 X	⊕ II 2G Ex mb IIC T6 Gb ⊕ II 2D Ex mb IIIC T80°C Db	
Weitere angewandte EU-Richtlinien / Additionally applied EU directives	Harmonisierte Normen / Harmonised standards	Anmerkungen / Comments
2014/35/EU Niederspannungsrichtlinie / 2014/35/EU Low Voltage Directive	EN 60947-5-2:2007 + A1:2012	-
2014/30/EU EMV-Richtlinie / 2014/30/EU EMC Directive	nicht anwendbar nach EN 60947-1:2007 + A1:2011 + A2:2014 / not applicable to EN 60947-1:2007 + A1:2011 + A2:2014	-
2011/65/EU RoHS-Richtlinie / 2011/65/EU RoHS Directive	EN IEC 63000:2018	-

Benannte Stelle der EG-Baumusterprüfung /
Notified body for EU-type examination: Dekra Testing and Certification GmbH
Dinnendahlstr. 9
44809 Bochum
Kenn-Nr. 0158

Überwachende Stelle nach Anhang IV/VII der
Richtlinie 2014/34/EU /
Notified body according to Annex IV/VII of
Directive 2014/34/EU: Dekra Testing and Certification GmbH
Dinnendahlstr. 9
44809 Bochum
Kenn-Nr. 0158

Verantwortlich technische Dokumentation /
Responsible for technical documentation: Marc Stanesby (Geschäftsführer)
Marc Stanesby (Managing Director)

Löhne, 30. November 2022 / 30 November, 2022
Ort und Datum der Ausstellung / Place and date of issue

steute Technologies GmbH & Co KG, Brückenstr. 91, 32584 Löhne, Germany

Marc Stanesby

Rechtsverbindliche Unterschrift,
Marc Stanesby (Geschäftsführer) /
Legally binding signature,
Marc Stanesby (Managing Director)

21. EC-Type Examination Certificate Magnetic reed switch (F0)



Translation

1 EU-Type Examination Certificate Supplement 7

2 Equipment intended for use in potentially explosive atmospheres
Directive 2014/34/EU

3 EU-Type Examination Certificate Number: **DMT 01 ATEX E 058 X**

4 Product: **Magnetic switch type Ex RC*******

5 Manufacturer: **steute Technologies GmbH & Co. KG**

6 Address: **Brückenstraße 91, 32584 Löhne, Germany**

7 This supplementary certificate extends EU-Type Examination Certificate No. DMT 01 ATEX E 058 X to apply to products designed and constructed in accordance with the specification set out in the appendix of the said certificate but having any acceptable variations specified in the appendix to this certificate and the documents referred to therein.

8 DEKRA Testing and Certification GmbH, Notified Body number 0158, in accordance with Article 17 of Directive 2014/34/EU of the European Parliament and of the Council, dated 26 February 2014, certifies that this product has been found to comply with the Essential Health and Safety Requirements relating to the design and construction of products intended for use in potentially explosive atmospheres given in Annex II to the Directive.
The examination and test results are recorded in the confidential Report No. BVS PP 01.2051 EU.

9 The Essential Health and Safety Requirements are assured in consideration of:

EN IEC 60079-0:2018 General requirements
EN 60079-18:2015+A1:2017 Encapsulation "m"

10 If the sign "X" is placed after the certificate number, it indicates that the product is subject to the Special Conditions for Use specified in the appendix to this certificate.

11 This EU-Type Examination Certificate relates only to the design and construction of the specified product. Further requirements of the Directive apply to the manufacturing process and supply of this product. These are not covered by this certificate.

12 The marking of the product shall include the following:

 **II 2G Ex mb IIC T6 Gb**
II 2D Ex mb IIIC T80°C Db

DEKRA Testing and Certification GmbH
Bochum, 2019-10-22

Signed: Jörg-Timm Kilisch

Managing Director



Page 1 of 4 of DMT 01 ATEX E 058 X / N7
This certificate may only be reproduced in its entirety and without any change.

DEKRA Testing and Certification GmbH, Handwerksstr. 15, 70565 Stuttgart, Germany
Certification body: Dinnendahlstr. 9, 44809 Bochum, Germany
Phone +49.234.3696-400, Fax +49.234.3696-401, e-mail DTC-Certification-body@dekra.com



13 Appendix
 14 EU-Type Examination Certificate

DMT 01 ATEX E 058 X
 Supplement 7

15 Product description

15.1 Subject and type

Magnetic switch type Ex RC*****

- 1. Asterisk Housing design:
 - 12 Diameter 12 mm
 - 13.5 Diameter 13.5 mm
 - M14 Mounting thread M14 x 1
 - 15 Diameter 15 mm
 - M20 Mounting thread M20 x 1,5
 - 2580 Housing dimensions 25 mm x 80 mm
- 2. Asterisk Contact function:
 - W Change-over contact
 - Wr Change-over contact latching
 - S Normally open contact
 - Sr Normally open contact latching
 - O Normally closed contact
- 3. Asterisk Cable length
- 4. Asterisk Housing material
 - Blank Brass
 - KST Thermoplastic
 - Niro Stainless steel
- 5. Asterisk Lower ambient temperature range
 - Blank -20 °C
 - 40 °C -40 °C
 - 50 °C -50 °C
 - 60 °C -60 °C
- 6. Asterisk Allowed impact
 - Blank 7 Joule
 - 4J 4 Joule
- 7. Asterisk Approval
 - GL German Lloyd

15.2 Description

The magnetic switch is designed in type of protection Encapsulation "m" and will be used for the implementation of switching operations.

Reason for this supplement:

- Extension of the type code
- Updating of the applicable standards.
- New reed contacts DRS-DTH and HSR-834W
- Extension of the electrical rating
- New magnetic switch type Ex RC M20**KST -50 °C*



Page 2 of 4 of DMT 01 ATEX E 058 X / N7
 This certificate may only be reproduced in its entirety and without any change.
 DEKRA Testing and Certification GmbH, Handwerkstr. 15, 70565 Stuttgart, Germany
 Certification body: Dinnendahlstr. 9, 44809 Bochum, Germany
 Phone +49.234.3696-400, Fax +49.234.3696-401, e-mail DTC-Certification-body@dekra.com



15.3 Parameters

15.3.1 Electrical Data

Switching voltage	up to	AC	250	V
Switching current*	up to		1.5	A
or	up to		0.35	A
Switching power for change-over contact and for normally closed contact	up to		50	VA/W
Switching power for normally open contact	up to		100	VA/W
Short-circuit current I_k for change-over contact and for normally closed contact	up to		2	A
Short-circuit current I_k for normally open contact up to			5	A

* = depending on reed contact used

15.3.2 Thermal Data

Ambient temperature range (Marking on the nameplate)	-20 °C up to +40 °C
or	-20 °C up to +70 °C
or	-40 °C up to +70 °C
or	-50 °C up to +70 °C
or	-60 °C up to +70 °C

16 Report Number

BVS PP 01.2051 EU, as of 2019-10-22

17 Special Conditions for Use

- 17.1 The ends of the permanent cables have to be connected inside enclosures that have been certified for the use in the relevant category accordingly.
- 17.2 The short circuit current I_k of the supply source may not exceed the mentioned parameters in 15.3.1, ensured by an external protective device.
- 17.3 The magnetic switch type Ex RC 12***** must be assembled in a way that is protected from mechanical hazards.
- 17.4 The magnetic switch type Ex RC*****4J must be assembled in a way that is protected from mechanical hazards.



Page 3 of 4 of DMT 01 ATEX E 058 X / N7
This certificate may only be reproduced in its entirety and without any change.

DEKRA Testing and Certification GmbH, Handwerkstr. 15, 70565 Stuttgart, Germany
Certification body: Dinnendahlstr. 9, 44809 Bochum, Germany
Phone +49.234.3698-400, Fax +49.234.3698-401, e-mail DTC-Certification-body@dekra.com



18 **Essential Health and Safety Requirements**

The Essential Health and Safety Requirements are covered by the standards listed under item 9.

19 **Drawings and Documents**

Drawings and documents are listed in the confidential report.

We confirm the correctness of the translation from the German original.
In the case of arbitration only the German wording shall be valid and binding.

DEKRA Testing and Certification GmbH
Bochum, 2019-10-22
BVS-Pe/Mu A 20190753



Managing Director

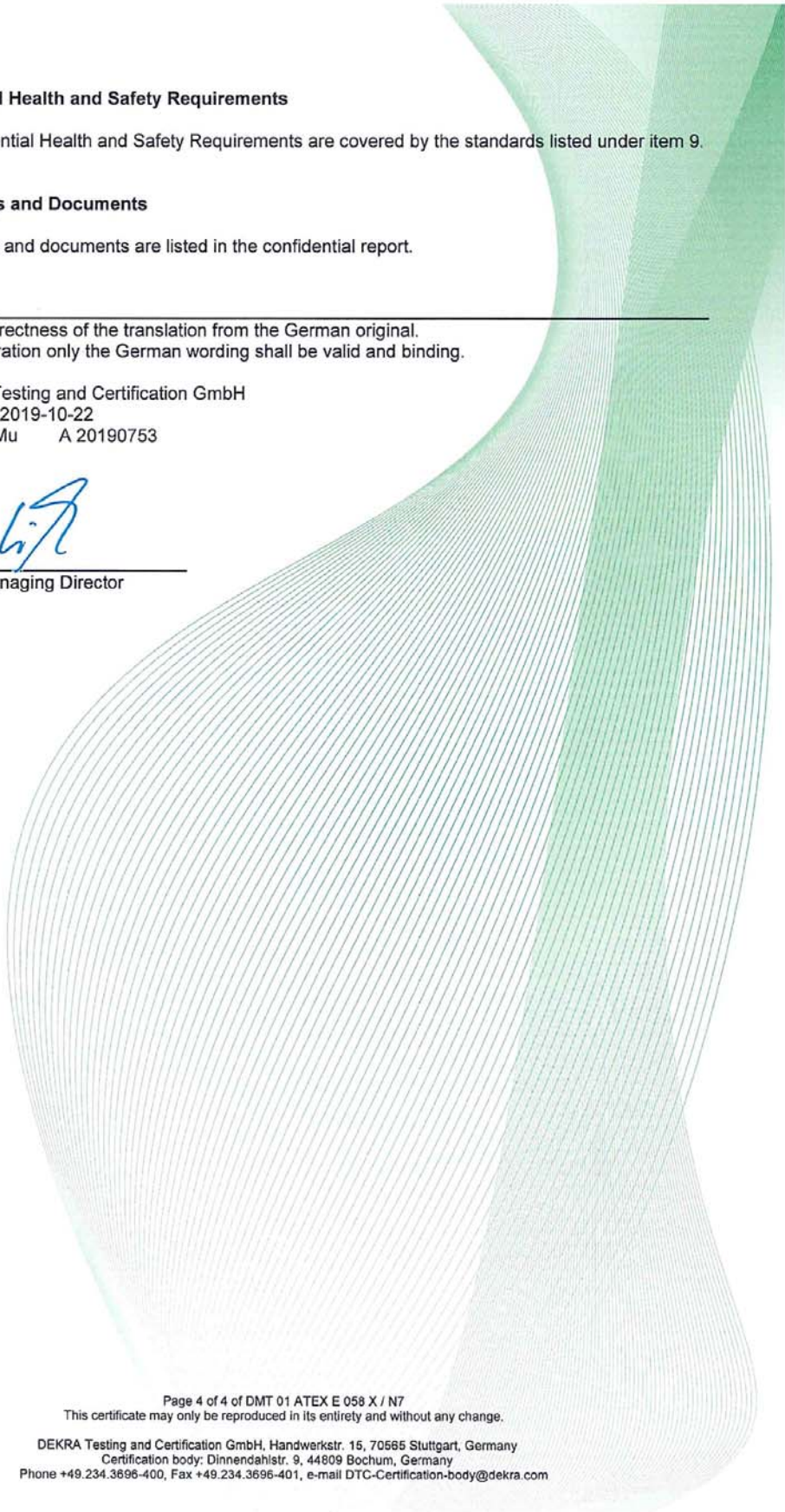



Page 4 of 4 of DMT 01 ATEX E 058 X / N7
This certificate may only be reproduced in its entirety and without any change.
DEKRA Testing and Certification GmbH, Handwerkstr. 15, 70565 Stuttgart, Germany
Certification body: Dinnendahlstr. 9, 44809 Bochum, Germany
Phone +49.234.3696-400, Fax +49.234.3696-401, e-mail DTC-Certification-body@dekra.com

22. IECEx certificate (F0)

		<h3>IECEX Certificate of Conformity</h3>	
INTERNATIONAL ELECTROTECHNICAL COMMISSION IEC Certification System for Explosive Atmospheres <small>for rules and details of the IECEx Scheme visit www.iecex.com</small>			
Certificate No.:	IECEX BVS 07.0007X	Page 1 of 4	<u>Certificate history:</u>
Status:	Current	Issue No: 4	Issue 3 (2019-02-27)
Date of Issue:	2019-10-24		Issue 2 (2016-10-07)
			Issue 1 (2014-05-12)
			Issue 0 (2007-04-12)
Applicant:	Steute Technologies GmbH & Co. KG Brückenstraße 91 32584 Löhne Germany		
Equipment:	Magnetic switch type Ex RC*****		
Optional accessory:			
Type of Protection:	Equipment protection by encapsulation "m"		
Marking:	Ex mb IIC T6 Gb Ex mb IIIC T80°C Db		
Approved for issue on behalf of the IECEx Certification Body:	Dr Franz Eickhoff		
Position:	Deputy Head of Certification Body		
Signature: (for printed version)			
Date:			
1. This certificate and schedule may only be reproduced in full. 2. This certificate is not transferable and remains the property of the issuing body. 3. The Status and authenticity of this certificate may be verified by visiting www.iecex.com or use of this QR Code.			
			
Certificate issued by: DEKRA Testing and Certification GmbH Certification Body Dinnendahlstrasse 9 44809 Bochum Germany		 DEKRA On the safe side.	

	<h2>IECEx Certificate of Conformity</h2>
Certificate No.: IECEx BVS 07.0007X	Page 2 of 4
Date of issue: 2019-10-24	Issue No: 4
Manufacturer: Steute Technologies GmbH & Co. KG Brückenstraße 91 32584 Löhne Germany	
Additional manufacturing locations:	
<p>This certificate is issued as verification that a sample(s), representative of production, was assessed and tested and found to comply with the IEC Standard list below and that the manufacturer's quality system, relating to the Ex products covered by this certificate, was assessed and found to comply with the IECEx Quality system requirements. This certificate is granted subject to the conditions as set out in IECEx Scheme Rules, IECEx 02 and Operational Documents as amended</p>	
STANDARDS : The equipment and any acceptable variations to it specified in the schedule of this certificate and the identified documents, was found to comply with the following standards	
IEC 60079-0:2017 Edition:7.0	Explosive atmospheres - Part 0: Equipment - General requirements
IEC 60079-18:2017 Edition:4.1	Explosive atmospheres - Part 18: Protection by encapsulation "m"
<p>This Certificate does not indicate compliance with safety and performance requirements other than those expressly included in the Standards listed above.</p>	
TEST & ASSESSMENT REPORTS: A sample(s) of the equipment listed has successfully met the examination and test requirements as recorded in:	
Test Report: DE/BVS/EXTR07.0008/03	
Quality Assessment Report: DE/BVS/QAR06.0023/11	

	<h2>IECEX Certificate of Conformity</h2>
Certificate No.: IECEX BVS 07.0007X	Page 3 of 4
Date of issue: 2019-10-24	Issue No: 4
EQUIPMENT: Equipment and systems covered by this Certificate are as follows:	
Description	
The magnetic switch is designed in type of protection Encapsulation "m" and will be used for the implementation of switching operations.	
Subject and Type	
See Annex	
Parameters	
See Annex	
SPECIFIC CONDITIONS OF USE: YES as shown below:	
<ul style="list-style-type: none">- The ends of the permanent cables have to be connected inside enclosures that have been certified for the use in the relevant Category accordingly.- The short circuit current I_k of the supply source may not exceed the mentioned parameters, ensured by an external protective device.- The magnetic switch type EX RC 12***** must be assembled in a way that is protected from mechanical hazards.- The magnetic switch type EX RC*****4 J must be assembled in a way that is protected from mechanical hazards.	

	<h2>IECEX Certificate of Conformity</h2>
Certificate No.: IECEX BVS 07.0007X	Page 4 of 4
Date of issue: 2019-10-24	Issue No: 4
DETAILS OF CERTIFICATE CHANGES (for issues 1 and above)	
<ul style="list-style-type: none">• Extension of the type code• Updating of the applicable standards.• New reed contacts DRS-DTH and HSR-834W• Extension of the electrical rating• New magnetic switch type Ex RC M20**KST -50 °C*	
Annex:	
BVS_07_0007X_Steute_Annex_issue4.pdf	



IECEx Certificate of Conformity



Certificate No.: IECEx BVS 07.0007X issue No.: 4
Annex
 Page 1 of 2

Subject and Type

Magnetic switch type Ex RC*****

- | | |
|-------------|---|
| 1. Asterisk | Housing design:
12 Diameter 12 mm
13.5 Diameter 13.5 mm
M14 Mounting thread M14 x 1
15 Diameter 15 mm
M20 Mounting thread M20 x 1,5
2580 Housing dimensions 25 mm x 80 mm |
| 2. Asterisk | Contact function:
W Change-over contact
Wr Change-over contact latching
S Normally open contact
Sr Normally open contact latching
Ö Normally closed contact |
| 3. Asterisk | Cable length |
| 4. Asterisk | Housing material
Blank Brass
KST Thermoplastic
Niro Stainless steel |
| 5. Asterisk | Lower ambient temperature range
Blank -20 °C
-40 °C -40 °C
-50 °C -50 °C
-60 °C -60 °C |
| 6. Asterisk | Allowed impact
Blank 7 Joule
4J 4 Joule |
| 7. Asterisk | Approval
GL German Lloyd |



IECEX Certificate of Conformity



Certificate No.: **IECEX BVS 07.0007X issue No.: 4**
Annex
Page 2 of 2

Parameters

Electrical Data

Switching voltage	up to	AC	250	V
Switching current*	up to		1.5	A
or	up to		0.35	A
Switching power for change-over contact and for normally closed contact	up to		50	VA/W
Switching power for normally open contact	up to		100	VA/W
Short-circuit current I _k for change-over contact and for normally closed contact	up to		2	A
Short-circuit current I _k for normally open contact	up to		5	A

* = depending on reed contact used

Thermal Data

Ambient temperature range (Marking on the nameplate)	-20 °C up to +40 °C
or	-20 °C up to +70 °C
or	-40 °C up to +70 °C
or	-50 °C up to +70 °C
or	-60 °C up to +70 °C