



Mass Flowmeter for gases



measuring
•
monitoring
•
analysing

MAS



- Measuring range:
0-10 Nml/min ... 0-500 NI/min
- Accuracy: $\pm 1.5\%$ of full scale
- p_{\max} 35 bar; t_{\max} 50 °C
- Analogue output:
0-5 V or 4-20 mA
- Digital display
- Material: Nylon®, stainless steel
- Bypass measuring system
laminar flow

SS



KOBOLD companies worldwide:

AUSTRALIA, AUSTRIA, BELGIUM, BULGARIA, CANADA, CHINA, CZECHIA, FRANCE, GERMANY, GREAT BRITAIN, HUNGARY, INDIA, INDONESIA, ITALY, MALAYSIA, MEXICO, NETHERLANDS, PERU, POLAND, REPUBLIC OF KOREA, RUSSIA, SPAIN, SWITZERLAND, THAILAND, TUNISIA, TURKEY, USA, VIETNAM

KOBOLD Messring GmbH
Nordring 22-24
D-65719 Hofheim/Ts.
☎ Head Office:
+49(0)6192 299-0
☎ +49(0)6192 23398
info.de@kobold.com
www.kobold.com

Fields of Application

The KOBOLD MAS model mass flowmeter makes very precise measurements of the mass flow rate of gases in different measuring ranges from 0-10 Nml/min to 0-500 NI/min nitrogen. The operation of the meter is based on the calorimetric principle. For indication of 98% of the actual flow, the response time is 2 s. The meter may be installed in any position.

In contrast with most volumetric flowmeters, no temperature or pressure correction is required.

This means that the MAS model is ideally suited for almost every gas flow application. Typical industrial applications are process control, laboratory measuring tasks, OEM applications, gas indication panels, leakage and filter monitoring.

The MAS is available either with analogue output only, or in addition with digital indication. The 3½-digit LCD display is infinitely rotatable through 180°. Glass-fibre-reinforced Nylon® or stainless steel may be used in the manufacture of wetted parts. Seal materials is FPM (Kalrez or Neoprene upon request).

The MAS model may be operated with 12-15 V_{DC}. MAS-5015 or MAS-5000 are recommended as power supplies.

Typically, a 0-5 V_{DC} (or 4-20 mA optional) analogue signal is available as output signal. This allows recording, data storage, and control functions to be implemented.

Theory of Operation

The medium flows through the bypass measuring system. The resulting differential pressure between P1 and P2 causes a small amount of gas to flow through the overhead measuring tube. The separation ratio is constant.

Two resistance temperature detectors (RTD elements) transferring a constant amount of heat to the gas stream are mounted on the measuring tube.

Under flow conditions, the gas molecules absorb and transport the heat away. This gives rise to a temperature difference between the two detector coils, which causes a change in resistance in the detector coils, whereby R1 <> R2. The electronics converts the signal for indication. The temperature difference increases as the flow increases.

Design

Direct indication of mass flow rate
no temperature or pressure correction needed

Digital display
shows the mass flow rate in Nml/min or NI/min. (other units upon request)

Tilting indicator
may be tilted through 180°, 9 adjustments

Output connector
9 Pin »D« Sub-type, Output signal 0-5 V_{DC} or 4-20 mA optional analogue output

Mains plug
Input voltage 12 V_{DC}

Pipe unions
possible with ¼ FNPT or ¼" Swagelok® connections

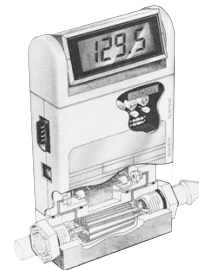

Zero-point and span potentiometers
adjustable from outside

Measuring tube

Laminar flow bypass
comes in 20 ranges from 0-10 Nml/min to 0-500 l/min

Flowmeter body
wetted parts either Nylon® or steel

Special Advantages

- Direct mass flow measurement
- No pressure or temperature correction needed
- Large measuring range
- Negligible pressure loss
- May be fitted in any position
- High degree of repeatability
- Analogue output 0-5 V_{DC}, option 4-20 mA

Measuring tube design

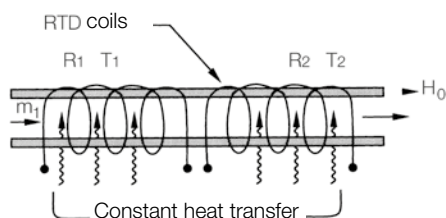

Flow diagram

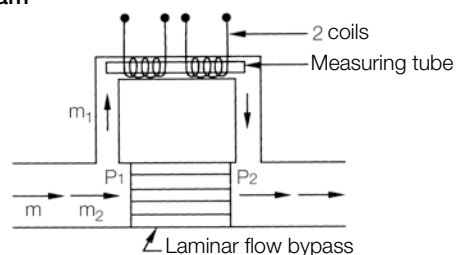

Technical Details

Field of application: suited only for dry, oil-free gases

Measuring accuracy: $\pm 1.5\%$ of full scale (with calibrated performance characteristics, otherwise observe pressure and temperature coefficients)

Option: $\pm 1\%$ of full scale (only to 0-100 Nml/min measuring range with stainless steel case)

Standard calibration: 1013.25 mbar abs., 0 °C
option: to customer specification

Temperature coefficient: 0.15% of full scale / °C

Pressure coefficient: 0.3% of full scale / bar

Repeatability: $\pm 0.5\%$ of full scale

Response time: 800 ms time constant; 6 s (typical) to within $\pm 2\%$ of final value over 25-100% of full scale

Max. medium, and ambient temperature: 50 °C

Max. operating pressure: Nylon®: 10 bar
stainless steel: 35 bar

Installation position: any

Gas leak rate: 1×10^{-4} ml/s He (Nylon®)
 1×10^{-7} ml/s He (st. steel case)

Wetted parts: 5% either glass-fibre-reinforced Nylon® or stainless steel material no. 1.4401

Seals: FPM (others upon request)

Supply voltage: 12-15 V_{DC}

Output: linear 0-5 V_{DC} (load min. 2000 Ω)
option: 4-20 mA (load max. 500 Ω)

Connection diagram

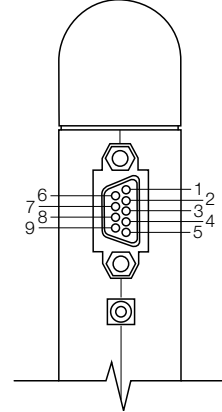

PIN No. function

- 1 No connection
- 2 Flow rate signal ground
- 3 0-5 V_{DC} flow rate signal
- 4 + mains supply (12 V_{DC})¹⁾
- 5 External display signal
- 6 External display ground
- 7 Mains supply ground
- 8 Analogue output 4-20 mA ground
- 9 Analogue output 4-20 mA signal

¹⁾ Do not connect if the device is already supplied from the mains socket.

Dimensions [mm]

Case L (Stainless steel and Nylon®)

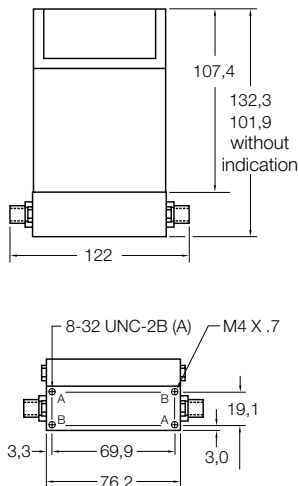

Case M (Stainless steel)

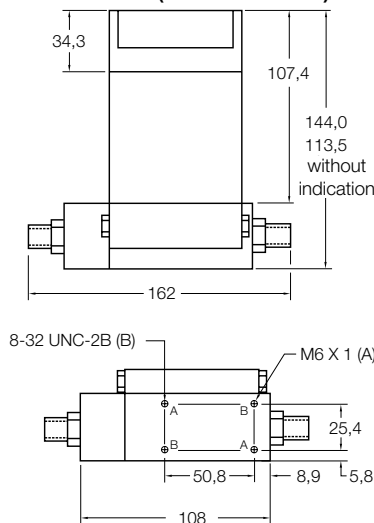

Case H (Stainless steel)

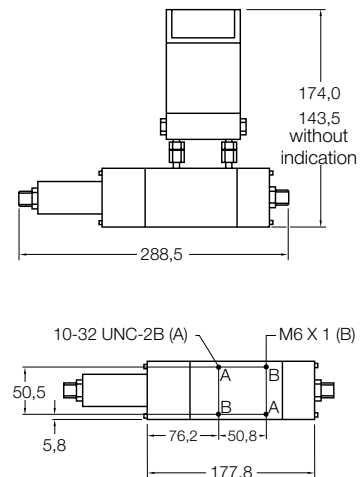



Order details Nylon® version, only for air/N₂ (example: MAS-1002 00 V2 0)

Measuring range for N ₂	Max. pressure loss	Model			Connection	Voltage supply	Output
		with display	with counter	without display			
0-20 Nml/min	1 mbar	MAS-1002	MAS-1102	MAS-2002	00 = ¼" NPT female C2 = Swagelok® ¼"	00 = 12 V _{DC}	0 = 0-5 V _{DC} A = 4-20 mA
0-50 Nml/min	1 mbar	MAS-1003	MAS-1103	MAS-2003			
0-100 Nml/min	1 mbar	MAS-1004	MAS-1104	MAS-2004			
0-200 Nml/min	1 mbar	MAS-1005	MAS-1105	MAS-2005			
0-500 Nml/min	1 mbar	MAS-1006	MAS-1106	MAS-2006			
0-1 NI/min	1 mbar	MAS-1007	MAS-1107	MAS-2007			
0-2 NI/min	6 mbar	MAS-1008	MAS-1108	MAS-2008			
0-5 NI/min	6 mbar	MAS-1009	MAS-1109	MAS-2009			
0-10 NI/min	6 mbar	MAS-1010	MAS-1110	MAS-2010			
0-20 NI/min	25 mbar	MAS-1011	MAS-1111	MAS-2011			
0-30 NI/min	47 mbar	MAS-1012	MAS-1112	MAS-2012			
0-40 NI/min	88 mbar	MAS-1013	MAS-1113	MAS-2013			
on customer specification		MAS-10XX	MAS-11XX	MAS-20XX			

Order details stainless steel version (example: MAS-3001 C1 V2 0)

Measuring range for N ₂	Max. pressure loss	Case size	Model			Connection	Voltage supply	Output
			with display	with counter	without display			
0-10 Nml/min	6 mbar	L	MAS-3001	MAS-3101	MAS-4001	C1 = Swagelok® ⅛" C2 = Swagelok® ¼" C3 = Swagelok® ⅜"	00 = 12 V _{DC}	0 = 0-5 V _{DC} A = 4-20 mA
0-20 Nml/min	6 mbar	L	MAS-3002	MAS-3102	MAS-4002			
0-50 Nml/min	6 mbar	L	MAS-3003	MAS-3103	MAS-4003			
0-100 Nml/min	6 mbar	L	MAS-3004	MAS-3104	MAS-4004			
0-200 Nml/min	6 mbar	L	MAS-3005	MAS-3105	MAS-4005			
0-500 Nml/min	6 mbar	L	MAS-3006	MAS-3106	MAS-4006			
0-1 NI/min	6 mbar	L	MAS-3007	MAS-3107	MAS-4007			
0-2 NI/min	6 mbar	L	MAS-3008	MAS-3108	MAS-4008			
0-5 NI/min	6 mbar	L	MAS-3009	MAS-3109	MAS-4009			
0-10 NI/min	105 mbar	L	MAS-3010	MAS-3110	MAS-4010	C2 = Swagelok® ¼" C3 = Swagelok® ⅜" C4 = Swagelok® ½"	00 = 12 V _{DC}	0 = 0-5 V _{DC} A = 4-20 mA
0-15 NI/min	105 mbar	L	MAS-3011	MAS-3111	MAS-4011			
0-20 NI/min	40 mbar	M	MAS-3012	MAS-3112	MAS-4012			
0-30 NI/min	60 mbar	M	MAS-3013	MAS-3113	MAS-4013			
0-50 NI/min	80 mbar	M	MAS-3014	MAS-3114	MAS-4014			
0-100 NI/min	105 mbar	M	MAS-3015	MAS-3115	MAS-4015			
0-100 NI/min	6 mbar	H	MAS-3016	MAS-3116	MAS-4016			
0-200 NI/min	6 mbar	H	MAS-3017	MAS-3117	MAS-4017			
0-300 NI/min	140 mbar	H	MAS-3018	MAS-3118	MAS-4018			
0-400 NI/min	140 mbar	H	MAS-3019	MAS-3119	MAS-4019			
0-500 NI/min	140 mbar	H	MAS-3020	MAS-3120	MAS-4020			
on customer specification		L	MAS-30LX	MAS-31LX	MAS-40LX	C1 / C2 / C3	00 = 12 V _{DC}	0 = 0-5 V _{DC} A = 4-20 mA
on customer specification		M	MAS-30MX	MAS-31MX	MAS-40MX			
on customer specification		H	MAS-30HX	MAS-31HX	MAS-40HX			

When placing an order, please specify detailed service conditions (type of gas, flow rate, pressure, temperature etc.)

Accessories: Connector power supply

Model	Input	Output
MAS-5000	110 V _{AC}	12 V _{DC} / 1.9 W
MAS-5015	230 V _{AC}	15 V _{DC} / 6 W